



**EM**  
ENGINEERING MANUAL

***Movex***<sup>®</sup>

working in partnership with



## **APPLICATION CONSIDERATIONS.**

The proper selection and application of Movex® products and components, including the related area of product safety, is the responsibility of the customer. Operating and performance requirements and potential associated issues will vary appreciably depending upon the use and application of such products and components. The scope of the technical and application information included in this publication is necessarily limited. Unusual operating environments and conditions, lubrication requirements, loading supports, and other factors can materially affect the application and operating results of the products and components and the customer should carefully review its requirements. Users of our products should make their own tests to determine the suitability of any product for their particular purposes.

Any technical advice or review furnished by Movex® with respect to the use of products and components is given in good faith and without charge, and Movex® assumes no obligation or liability for the advice given, or results obtained, all such advice and review being given and accepted at customer's risk.

For a copy of our Standard Terms and Conditions of Sale, Disclaimers of Warranty, Limitation of Liability and Remedy, please see our web site [www.movexii.com](http://www.movexii.com) or contact our Customer Service.

These terms and conditions of sale, disclaimers and limitations of liability apply to any person who may buy, acquire, or use any Movex® product referred to herein, including any person who buys from a licensed distributor of these branded products.

The applicable Movex® product catalogs and installation/maintenance bulletins must be used only by qualified individuals familiar with Movex® products; these documents contain important precautions and other information intended to reduce the risk of bodily injury. Refer to these documents before specifying, installing, operating, or servicing equipment.

Incorrect and/or incomplete data could cause the selection of improper components, potentially resulting in bodily injury. Movex® makes no warranties, express or implied, of merchantability or fitness for a particular purpose.

Movex® will not be liable for direct or indirect incidental, consequential, or punitive damages arising from the use or inability to use this any of the information made available, including but not limited to product literature, selection programs, and interchange guides. Movex® reserves the right to correct, modify, update and/or enhance these documents at any time without notice or penalty, including but not limited to pricing, technical data, etc. Most updated documents can always be found on the website. For more technical information, contact our Technical Support.

### **© Copyright Movex S.p.A. 2021**

The contents of this manual are the copyright of the publisher and may not be reproduced (even extracts) unless permission is granted.

Every care has been taken to ensure the accuracy of the information contained in this publication, but no liability can be accepted for any error or omission.

**Catalogue N° M999578**

# TABLE OF CONTENTS

---

## CHAPTER 1 - GENERAL SELECTION GUIDELINES

### CHAINS & BELTS

1.1 Application working range & guide selection .....	10
1.2 Chain & belt material - Features .....	16
1.3 Chain & belt material- Typical applications (Product related) .....	17
1.4 Chain & belt material - Typical applications (Operating conditions related) .....	18

### CURVES

1.5 Curve material .....	18
1.6 RS curves .....	19

## CHAPTER 2 - CONVEYOR CONSTRUCTION

### BELT SPROCKET POSITION

2.1 Sprocket position.....	21
510 Series & 520 HD FT - 520 PRO LBP .....	22
520 Series .....	23
521 Series - 522 HD .....	24
522 HD - One track belt .....	25
590 Series .....	26
590 Series - One track belt .....	27
590 Series - FTT .....	28
525 Series .....	29
530 Series .....	30
550 Series .....	31
551 Series .....	32
552 Series .....	33
552 Series - One track belt .....	34
553 Series .....	35
556 Series .....	36
600 Series - Standard .....	37
600 Series - Heavy duty .....	38
600 Series - Heavy duty with Bearings .....	40
600 Series - Small radius .....	42
600 Series - Heavy duty/Small radius .....	44
600 Series - Heavy duty/Small radius with Bearings .....	46
600 Series - Small radius section supports options .....	48
550 RR .....	49
Zero contact - Sprockets .....	50
Zero contact Pro - Sprockets .....	51
Zero contact Pro - 1 Track version .....	52
Zero contact Pro - 1 Track version with Bearings .....	58
Zero contact Pro - 2 Track version .....	60
2.2 Matching sprockets sizes - S & TOC dimension .....	64
2.3 Sprockets and idler bore tolerances .....	67
2.4 Fixed and floating sprockets/idlers on the shaft .....	68

## TABLE OF CONTENTS

---

<b>GENERAL INDICATIONS</b>	
2.5 Conveyor length and speed belts .....	69
2.6 Curve system - Bevel, Tab and Magnetic .....	71
2.7 Drive design .....	72
2.8 Roller diameters .....	74
2.9 Decline conveyors .....	75
2.10 Transfer .....	76
2.11 FTT transfers .....	77
2.12 Wear strip .....	78
2.13 Selection of wear strip material .....	79
2.14 Return system for standard applications .....	80
 <b>CHAPTER 3 - GRIPPER CHAIN</b>	
3.1 Recommendations for installations & maintenance .....	84
3.2 Selection guides .....	90
3.3 Checklist and protocol for gripper chain conveyor inspection .....	91
 <b>CHAPTER 4 - ZERO CONTACT</b>	
4.1 General maintenance .....	98
4.2 Sprocket selection .....	99
4.3 Support guide and return way .....	100
4.4 Inside rail and frame rail .....	100
4.5 Catenary and belt tension .....	101
4.6 Shaft bearings .....	102
4.7 Belt speed .....	102
4.8 Main components maintenance .....	103
4.9 Disassembling & assembling mode .....	104
4.10 Micropitch conveyor .....	105
4.11 Spare parts .....	106
4.12 Do's and don'ts .....	107
 <b>CHAPTER 5 - SIDE FLEXING BELTS</b>	
5.1 Side flexing belt overview .....	110
5.2 General recommendation .....	110
5.3 Conveyor layout recommendation .....	111
 <b>CHAPTER 6 - MATERIALS</b>	
<b>CHAIN &amp; BELT &amp; COMPONENTS MATERIALS</b>	
6.1 Application temperatures .....	114
6.2 Coefficients of friction .....	115
6.3 Heat expansion .....	116
6.4 Water absorption .....	117
6.5 Impact resistance .....	117
6.6 Expansion under tensile load .....	117

## TABLE OF CONTENTS

---

6.7	Wear resistance overview .....	118
6.8	PV .....	118
<b>CHEMICAL RESISTANCE</b>		
6.9	Chemical resistance – Table of substances .....	120
6.10	Chemical resistance – PH-range .....	123
6.11	Chemical resistance – General .....	123
<b>MATERIAL PROPERTIES</b>		
6.12	Rubber materials .....	123
6.13	Curve materials .....	124
6.14	Pin materials .....	124
6.15	Static electricity – AS material, black .....	125
6.16	BluLub .....	125
6.17	PFX .....	126
6.18	Steel chains – HB pins .....	127
6.19	Storage of plastic products .....	127
6.20	Note .....	127
<b>CHAPTER 7 - CLEANING</b>		
7.1	General .....	130
7.2	Frequency .....	130
7.3	Method .....	131
7.4	Chemical resistance .....	131
<b>CHAPTER 8 - INSPECTION GUIDELINES</b>		
8.1	Chain & belt .....	134
8.2	Sprockets & Idlers .....	135
8.3	Return rollers .....	135
8.4	Magnetic curves .....	135
8.5	Wear strip .....	136
8.6	Powder .....	136
8.7	Broken off pieces underneath the conveyor .....	136
8.8	Noise .....	137
8.9	Conveyor .....	138
8.10	Cleanliness .....	139
<b>CHAPTER 9 - ASSEMBLING MANUAL</b>		
9.1	Belts mounting option .....	142
9.2	Chain mounting block .....	144
9.3	Leveling feet - C500 Series .....	146
<b>APPLICATION QUESTIONNAIRE .....</b>		<b>149</b>
<b>SYNERGIA - CORPORATE SERVICE .....</b>		<b>152</b>

# Movex®



PRODUCTION  
CAPACITY

**16.500 Mq<sup>2</sup>**  
OF PRODUCTION SPACE

REFERENCE YEAR 2018

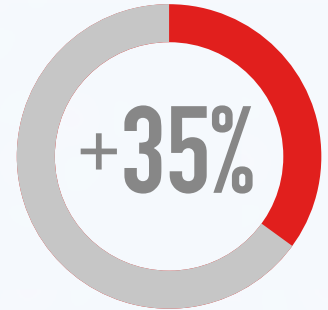

WAREHOUSE  
CAPACITY

**23.000+** DIFFERENT  
PRODUCTS AVAILABLE

**200+** EMPLOYEES  
AROUND THE WORLD



## MISSION

Creating value through innovative development of ideas, supporting our partners with professionalism, flexibility and effectiveness.

## VISION

Reaching market leadership as a reliable and precise supplier. Planning the future without losing sight of our history and the values that allow our growth.



## WE CREATE SOLUTIONS

In the new headquarters **Movex** designs and manufactures high quality components for the food, beverage, packaging, automotive and automation industries.

**Movex** meets your needs for standard and custom products in a dynamic and responsive way ensuring the best performance product with an attractive market price.



## RESEARCH & DEVELOPMENT

The rich experience that **Movex** has acquired over the years shows that care and innovation of products are essential to guarantee constant quality.

Thanks to the investments as well as developing strategic departments **Movex** has created new space where research and innovation become concrete tools to satisfy customers' requirements.

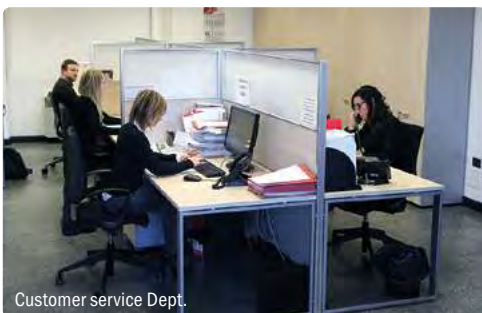

## WE SUPPORT YOU

A top service level is the goal of a qualified Engineering and Sales team with the objective of presenting **Movex** as a supplier of excellence to all clients.

Through a distribution/network which spans the globe, **Movex** offers technical support and a careful after-sales service, always at your disposal.



### Movex S.p.A. | Headquarter

Via Industria, 22 - 24060 Castelli Calepio (BG)  
P +39 035 8359711 | F +39 035 4420873  
[info@movexii.com](mailto:info@movexii.com)

### Movex S.p.A. | Logistics Center

Via Repubblica, 25  
24060 Castelli Calepio (BG)

## Movex around the world



### Movex GmbH

P +49-6204-9375-0



### Movex AG India

P +91-120-4159660-62



### Movex USA Inc.

P +1-919-274-5477



### Movex Brasil Ltda

P +55-15-3141-2550



### Movex UK Ltd.

P +44-77-20678442



### Movex SA de CV

P +52-1-3318458187



### Movex France

P +39-335-8085980



### Movex Nederland

P +31-630-994850



### Movex Russia

P +7 (495) 925-88-56



### Movex CIS countries

P +380-667507756

# GENERAL SELECTION GUIDELINES

*for typical and major applications out of the beverage field  
as well as other selected fields.*

***Movex***



# GENERAL SELECTION GUIDELINES

## CHAINS & BELTS

1.1 Application working range & guide selection .....	10
1.2 Chain & belt material - Features .....	16
1.3 Chain & belt material- Typical applications (Product related) .....	17
1.4 Chain & belt material - Typical applications (Operating conditions related) .....	18

## CURVES

1.5 Curve material .....	18
1.6 RS curves .....	19

# CHAINS & BELTS | 1.1 Application working range & selection guide

LEGEND: ● Application working range



Recommended choice	Wet application	
Speed		WORKING RANGE
Load		
Accumulation		
Cleanliness		
<b>Suggested belt/chain</b>		
Stainless steel chain		

Alternative choice	Dry application
<b>Suggested belt/chain</b>	
Modular belt   Flat Top version e.g. 550 FT series, MX/PFX material can be taken into consideration	



Recommended choice	Dry application	
Speed		WORKING RANGE
Load		
Accumulation		
Cleanliness		
<b>Suggested belt/chain</b>		
Modular belt   Flat Top version e.g. 550 FT series, MX/PFX material also possible: plastic chains 828 & 880M		

Alternative choice	Wet application
<b>Suggested belt/chain</b>	
Stainless steel chain	

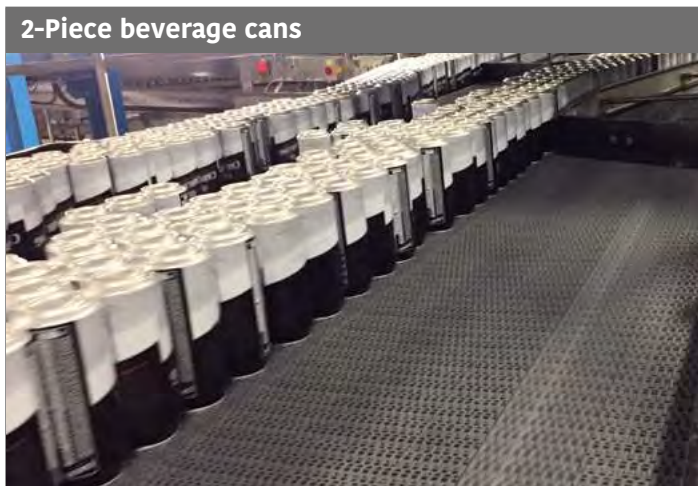

Recommended choice	Dry application	
Speed		WORKING RANGE
Load		
Accumulation		
Cleanliness		
<b>Suggested belt/chain</b>		
Modular belt   Flush Grid version, e.g. 550 FG series MX/PFX material		

# 1.1 Application working range & selection guide

LEGEND: ● Application working range

## PET bottle

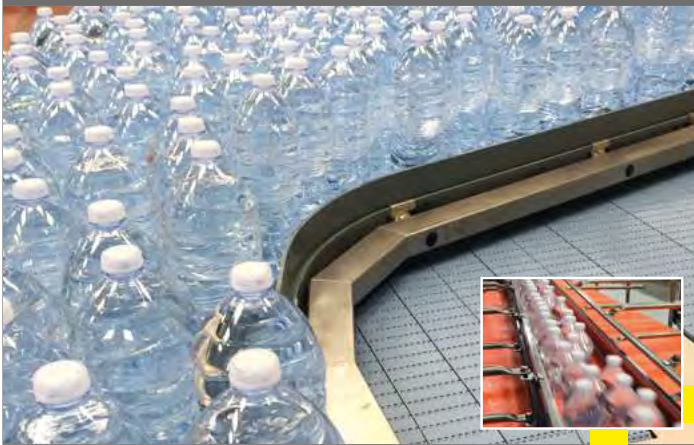

### Recommended choice Dry application

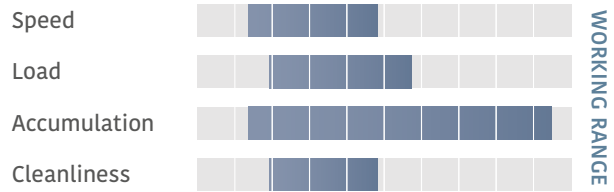

### Suggested belt/chain

Modular belt, Flat Top version, e.g. 550 FT series, MX/PFX material  
also possible: plastic chains 828 & 880 M

### Alternative choice Wet application

### Suggested belt/chain

LFA material

## Small bottles, Containers, applications requiring short product transfer plates



### Recommended choice Dry application

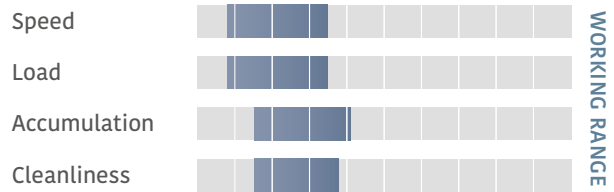

### Suggested belt/chain

Modular belt | Flush Grid version, e.g. 550 FG series  
MX/PFX material

## Crate



### Recommended choice Dry application

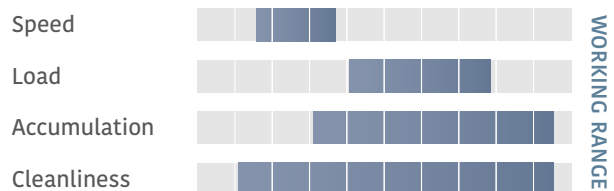

### Suggested belt/chain

Stainless steel chain  
& GT

GT: basically for inclines/declines and stop-divider applications

# 1.1 Application working range & selection guide

LEGEND: ● Application working range

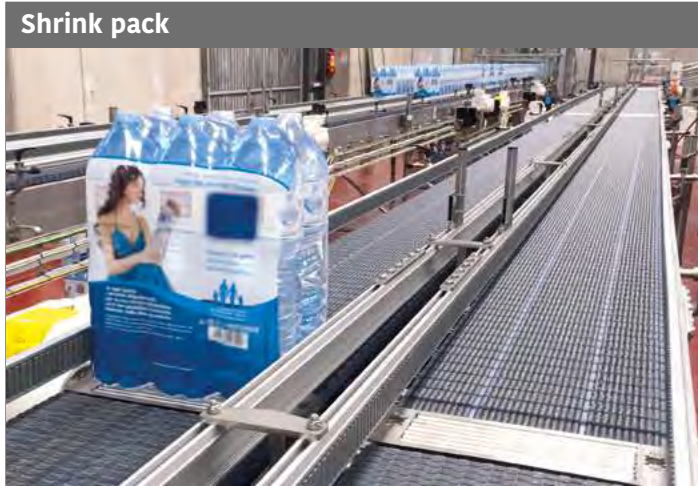

LBP: basically for accumulation  
GT: basically for inclines/declines and stop-divider applications

Recommended choice	Dry application	
Speed		WORKING RANGE
Load		
Accumulation		
Cleanliness		
<b>Suggested belt/chain</b>		
Modular belt, Flat Top & LBP & Grip Top version, e.g. 551 FT & LBP & GT or 520 FT & LBP & GT series, LFA material		
Plastic chain, e.g. 8257, 882 M, FT & LBP & GT version, LFA material		



Elevator, turner, rinser, washer applications

Recommended choice	Dry & wet application	
Speed		WORKING RANGE
Load		
Accumulation	NOT APPLICABLE	
Cleanliness		
<b>Suggested belt/chain</b>		
1873 GS chain, for light applications 878 GS chain		

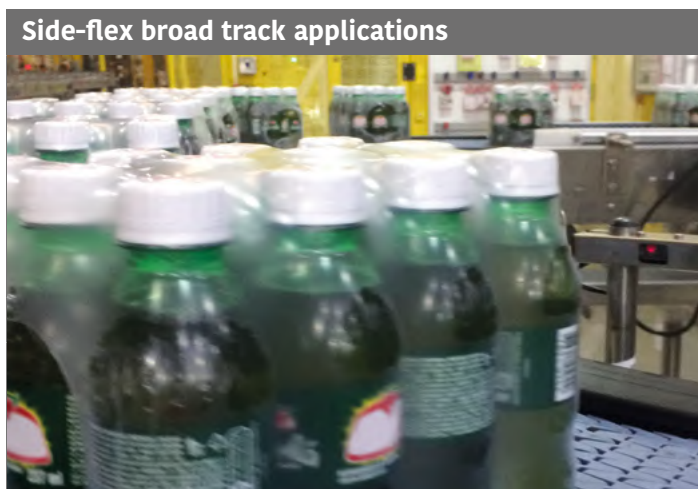

Side-flex broad track applications

GT: basically for inclines/declines and stop-divider applications





Recommended choice	Dry application	
Speed		WORKING RANGE
Load		
Accumulation		
Cleanliness		
<b>Suggested belt/chain</b>		
Side-flexing modular belt, 600, 556 & GT series		

# 1.1 Application working range & selection guide

LEGEND: ● Application working range







**Box**  
LBP: basically for accumulation  
GT: basically for inclines/declines and stop-divider applications

Recommended choice		Dry application 	
Speed		WORKING RANGE	
Load			
Accumulation			
Cleanliness			
<b>Suggested belt/chain</b>			
Modular belt, Flat Top & LBP & Grip Top version, e.g. 520 FT & LBP & GT, LFA material			
Plastic chain, e.g. 8257, 882 M, FT & LBP & GT version, LFA material			







**Various crates, boxes, packs in heavy duty curving applications**

Recommended choice		Dry application 	
Speed		WORKING RANGE	
Load			
Accumulation			
Cleanliness			
<b>Suggested belt/chain</b>			
Zero Contact, Zero Contact Pro, Zero Contact conveyor curves.			



**Pasteurizer, warmer, cooler applications**

Recommended choice		Dry application 	
Speed		WORKING RANGE	
Load			
Accumulation			
Cleanliness			
<b>Suggested belt/chain</b>			
500 RR raised rib belt			

# 1.1 Application working range & selection guide

LEGEND: ● Application working range



Recommended choice	Dry application	
Speed		WORKING RANGE
Load		
Accumulation		
Cleanliness		
<b>Suggested belt/chain</b>		
1701 series, 1706, 765 No Gap		

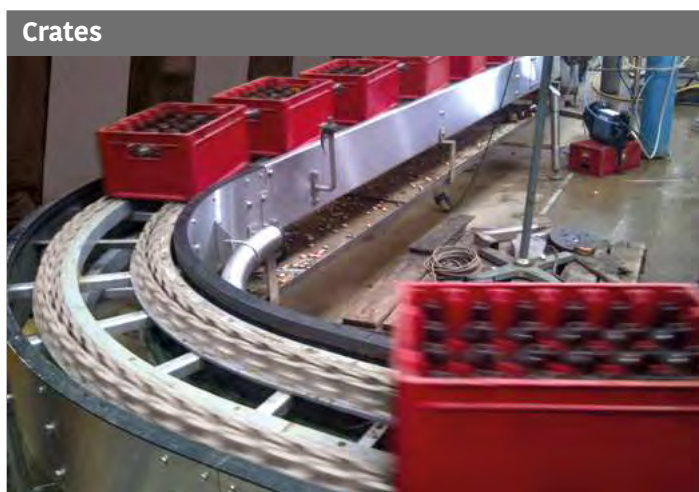

Recommended choice	Dry & wet application	
Speed		WORKING RANGE
Load		
Accumulation		
Cleanliness		
<b>Suggested belt/chain</b>		
CC600 & CC1400 series		

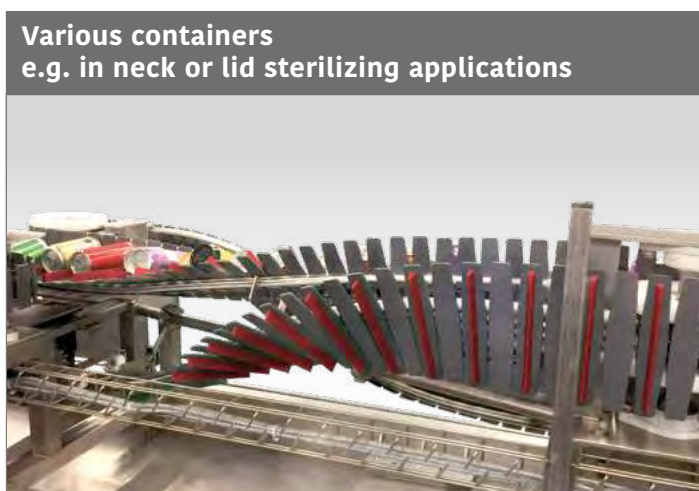





Recommended choice	Dry application	
Speed		WORKING RANGE
Load		
Accumulation	NOT APPLICABLE	
Cleanliness		
<b>Suggested belt/chain</b>		
1873 MX series		

# 1.1 Application working range & selection guide

LEGEND: ● Application working range



Recommended choice		Dry application 
Speed		WORKING RANGE
Load		
Accumulation	NOT APPLICABLE	
Cleanliness		
Suggested belt/chain		
SP 1883 series		

## 1.2 Chain & belt material - Features

### Coefficient of friction

Lower → Higher

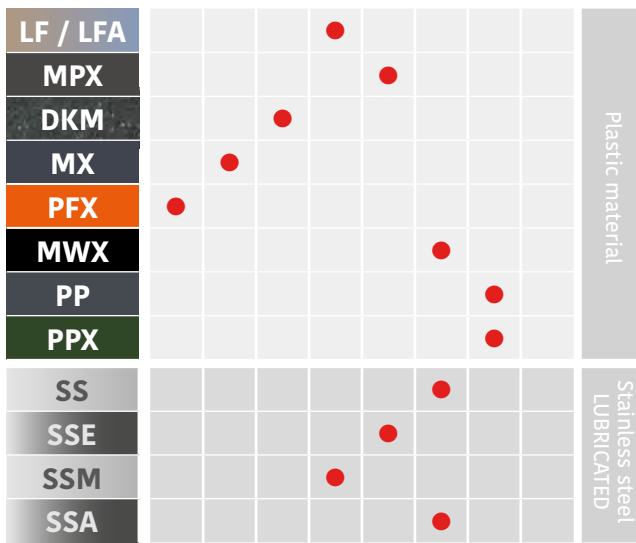

### Working load capacity

Lower → Higher

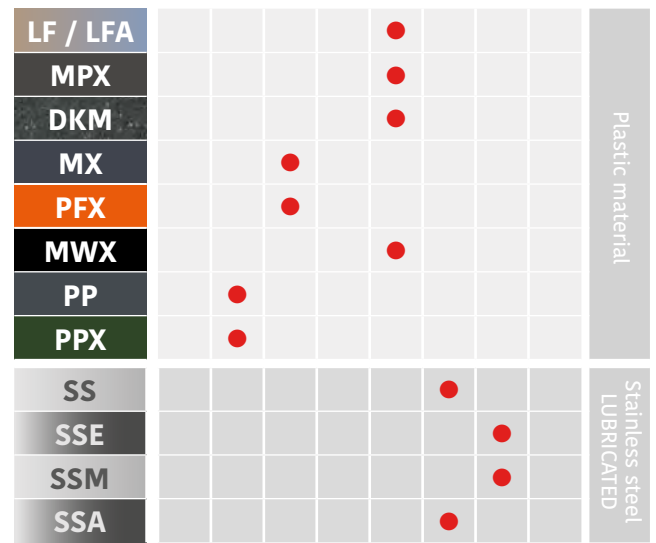

### Temperature resistance (Dry)

Lower → Higher

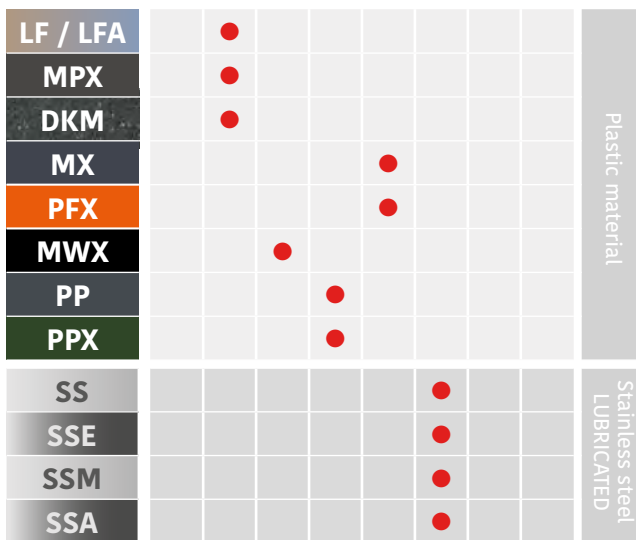

### Chemical resistance (Sour)

Lower → Higher

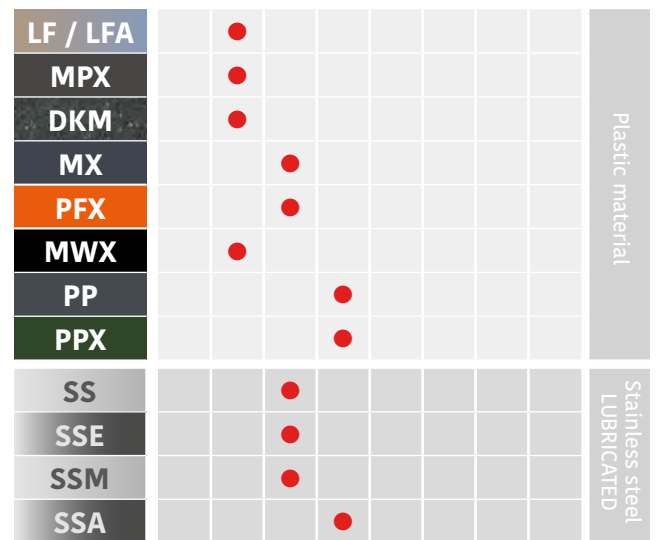

### Temperature resistance (Wet)

Lower → Higher

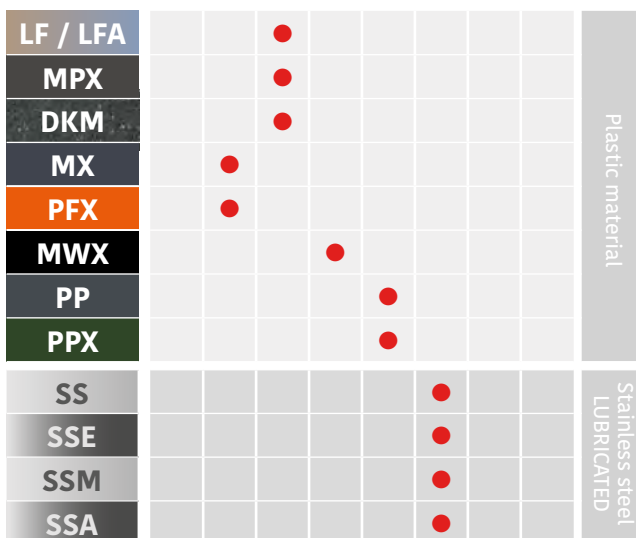

### Chemical resistance (Alcaline)

Lower → Higher

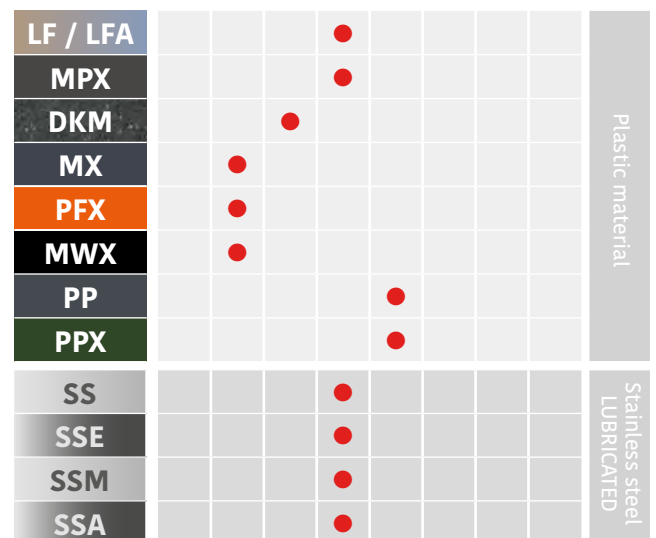



## 1.2 Chain & belt material - Features

### Wear resistance general

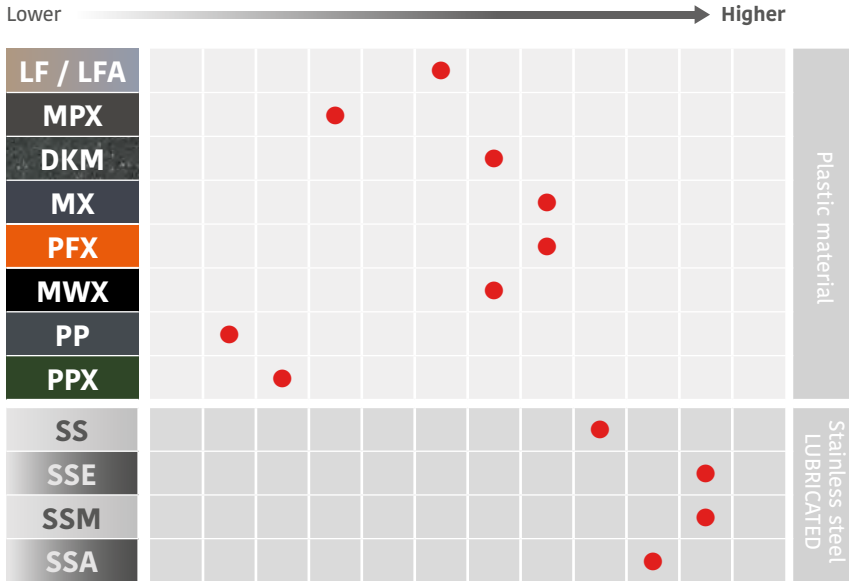

## 1.3 Chain & belt material - Typical application (Product related)

	Glass return		Glass new		Cans		PET		Crates		Shrink packs		Carton		
	DRY	LUBE	DRY	LUBE	DRY	LUBE	DRY	LUBE	DRY	LUBE	DRY	LUBE	DRY	LUBE	
LF / LFA	●	●	●	●	●	●	●	●	●	●	●		●		Plastic material
MPX	●	●	●	●	●	●	●	●	●	●	●		●		
DKM	●	●	●	●	●	●	●	●	●	●	●		●		
MX	●	●	●	●	●	●	●	●	●	●	●		●		
PFX	●	●	●	●	●	●	●	●	●	●	●		●		
MWX	●		● <sup>1</sup>		● <sup>2</sup>		●		●		●		●		
PP	●	●	●	●	●	●	●	●	●	●	●		●		
PPX	●	●	●	●	●	●	●	●	●	●	●		●		
SS		●		●				● <sup>3</sup>		●			●		Stainless steel
SSE		●		●				● <sup>3</sup>	●	●			●		
SSM		●		●				● <sup>3</sup>							
SSA		●		●				● <sup>3</sup>		●					

**LEGEND:**

- First choice      ● Second choice      ● Third choice      ● Special apps, only
- <sup>1</sup> Good for glass works      <sup>2</sup> Good for can twister feeding section      <sup>3</sup> Returnable PET
- <sup>4</sup> Good for apps requiring higher friction (GT Version is not possible)

## 1.4 Chain & belt material - Typical application (operating conditions related)

	High load	High speed	Accumulation	Inliner	Mass	Abrasive	Chemicals	Hot & Dry	Hot & Wet	Pasteurizer	
LF / LFA	● <b>B</b>	● <b>B</b>	●	●	●	● <b>C</b>	●	●	●	●	Plastic material
MPX	● <b>B</b>	● <b>B</b>	●	●	●	● <b>C</b>	●	●	●	●	
DKM	● <b>B</b>	● <b>B</b>	●	●	●	● <b>C</b>	●	●	●	●	
MX	● <b>B</b>	● <b>B</b>	●	●	●	● <b>C</b>	● <sup>3</sup>	●	●	●	
PFX	● <b>B</b>	● <b>B</b>	●	●	●	● <b>C</b>	● <sup>3</sup>	●	●	●	
MWX	● <b>B</b>	●	● <sup>1</sup>	●	●	● <b>C</b>	●	●	● <sup>4</sup>	●	
PP	●	●	●	●	●	●	●	●	●	●	
PPX	●	●	●	●	●	●	●	●	●	●	
SS	●	●	● <sup>2</sup>	●	●		●	●	●	●	Stainless steel
SSE	● <b>B</b>	● <b>B</b>	●	●	●	● <b>C</b>	●	●	●	●	
SSM	● <b>B</b>	● <b>B</b>	●	●	●	● <b>C</b>	●	●	●	●	
SSA	● <b>B</b>	● <b>B</b>	●	●	●	● <b>C</b>	●	●	●	●	

### LEGEND:

- First choice      ● Second choice      ● Third choice      ● Special apps, only
- <sup>1</sup> Good with abrasive conditions      <sup>2</sup> Good for slow accumulation tables
- <sup>3</sup> Good for paracetic acid      <sup>4</sup> Steam tunnel

### CURVE MATERIAL:

- B** *BluLub* material recommended
- C** "C" material optionally

## CURVES | 1.5 Curve material

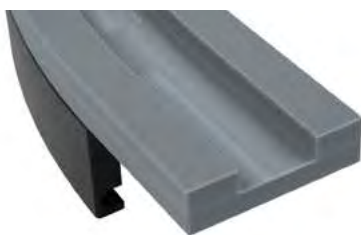

### **Standard**

UHMW-PE

e.g. lubricated steel & plastic chains and belts

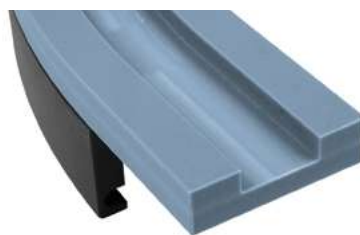

### **BluLub**

HIGH PERFORMANCE UHMW-PE

e.g. Dry running plastic chains and belts

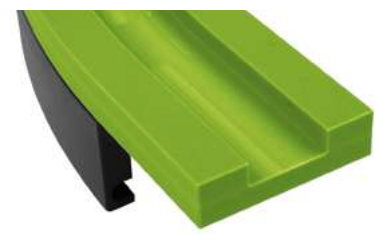

### **C** Abrasive

CONDITIONS

e.g. Dry running steel chains

Depending on application conditions various curve materials are suitable.

## 1.6 RS curves

# RS

*For major applications.*

The new product equipped with wear-strips in **BluLub** contributes to improved PV-properties compared to standard UHMW-PE curves.

The new curves **RS** are perfectly interchangeable with the traditional versions.



- Lower Friction
- Less Noise
- Replaceable Wear strip
- Minimized Downtime
- Less Wear
- Less Energy
- Easy to maintain
- Lower TCO

# RS CRATES

*Specific for high load applications.*

Also available in **C** Abrasive Version.



**C** Abrasive



**BluLub**

# RS PRO

*Specific for high speed applications.*

**RS PRO** is a patented system that consists of machined plastic curve tracks equipped with permanent magnets with a new curve-return concept.

This concept provides a total support of the chain/belt in the return of the curve.

Suitable for Chain-belts & Plastic chains: 260 M, 880 M

Patented

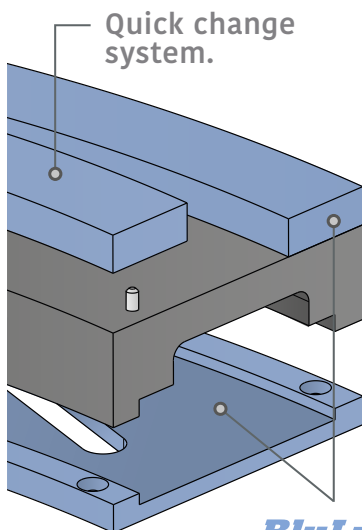

**BluLub**

The use of **RS PRO CURVE** avoid these typical wear areas.

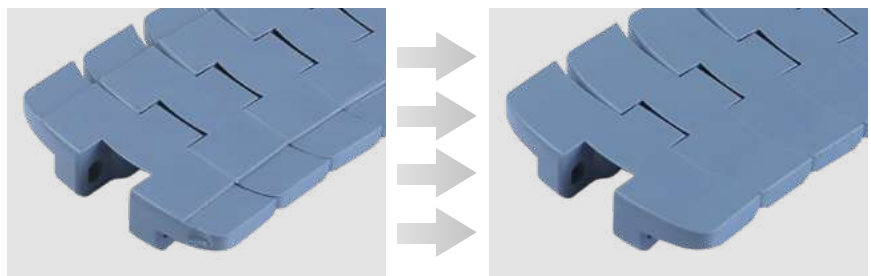

**RS PRO CURVE** means longer wearlife of chain and curve and permanent product stability.

# CONVEYOR CONSTRUCTION

*for typical and major applications out of the beverage field  
as well as other selected fields.*

***Movex***

# CONVEYOR CONSTRUCTION

## BELT SPROCKET POSITION

2.1 Sprocket position.....	21
510 Series & 520 HD FT - 520 Pro LBP .....	22
520 Series .....	23
521 Series - 522 HD.....	24
522 HD & 522 HD - One track belt .....	25
590 Series .....	26
590 Series - One track belt .....	27
590 Series - FTT .....	28
525 Series .....	29
530 Series .....	30
550 Series .....	31
551 Series .....	32
552 Series .....	33
552 Series - One track belt .....	34
553 Series .....	35
556 Series .....	36
600 Series - Standard .....	37
600 Series - Heavy duty .....	38
600 Series - Heavy duty with Bearings .....	40
600 Series - Small radius .....	42
600 Series - Heavy duty/Small radius .....	44
600 Series - Heavy duty/Small radius with Bearings .....	46
600 Series - Small radius section supports options .....	48
550 RR .....	49
Zero contact - Sprockets .....	50
Zero contact Pro - Sprockets .....	51
Zero contact Pro - 1 Track version .....	52
Zero contact Pro - 1 Track version with Bearings .....	58
Zero contact Pro - 2 Track version .....	60
2.2 Matching sprockets sizes - S & TOC dimension .....	64
2.3 Sprockets and idler bore tolerances .....	67
2.4 Fixed and floating sprockets/idlers on the shaft .....	68

## GENERAL INDICATIONS

2.5 Conveyor length and speed belts .....	69
2.6 Curve system - Bevel, Tab and Magnetic .....	71
2.7 Drive design .....	72
2.8 Roller diameters .....	74
2.9 Decline conveyors .....	75
2.10 Transfer .....	76
2.11 FTT transfers .....	77
2.12 Wear strip .....	78
2.13 Selection of wear strip material .....	79
2.14 Return system for standard applications .....	80

## 2.1 Sprockets position | 510 Series & 520 HD FT - 520 PRO LBP

Belt width (in/mm)	Recommended n° of sprockets*
--------------------	------------------------------

3 / 76.2	1
6 / 152.4	2
9 / 228.6	3
12 / 304.5	4
15 / 381.0	5
18 / 457.2	6
21 / 533.4	7
24 / 609.6	8

\*If more sprockets are required contact application engineering.

### IMPORTANT

- Add sprocket positions every 76,2 mm according to 76,2 mm width increments of the belt corresponding with 76,2 mm conveyor track pitch system.

⊗ It's **NOT** possible to place the sprockets in this position.

Belt width (in/mm)	Recommended n° of sprockets*
--------------------	------------------------------

85	1
170	2
255	3
340	4
425	5
510	6
595	7
680	8

\*If more sprockets are required contact application engineering.

### IMPORTANT

- Add sprocket positions every 85 mm according to 85 mm width increments of the belt corresponding with 85 mm conveyor track pitch system.

⊗ It's **NOT** possible to place the sprockets in this position.

#### SPROCKETS POSITION FOR: 510 FT

👁️ BOTTOM VIEW  
● Contact point

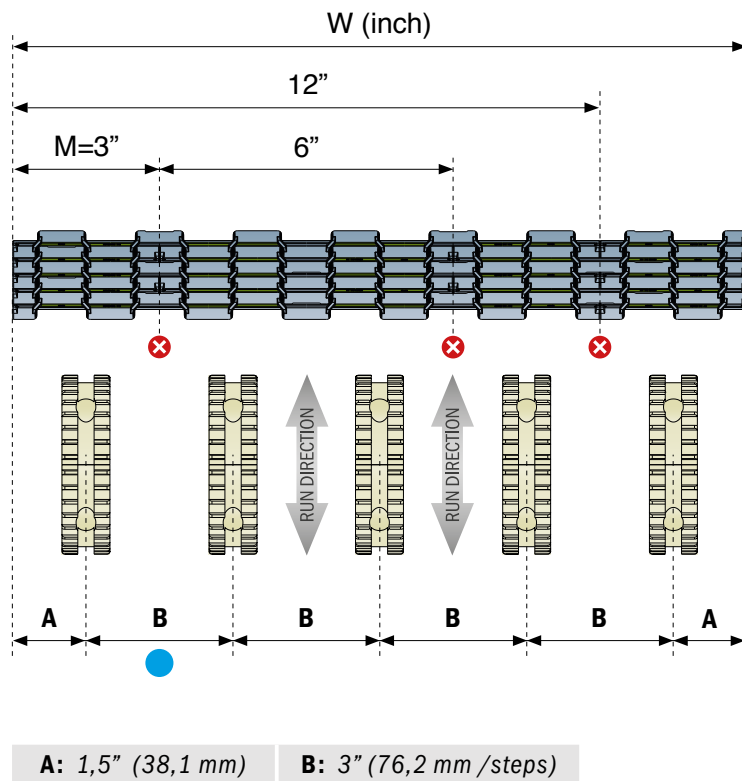

#### SPROCKETS POSITION FOR: 520 HD FT - 520 Pro LBP

👁️ BOTTOM VIEW  
● Contact point

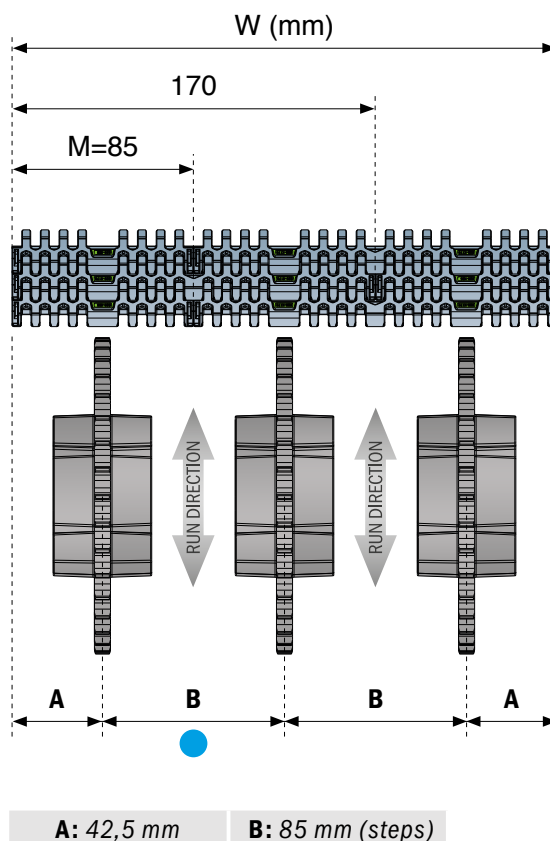

## 2.1 Sprockets position | 520 Series

SPROCKETS POSITION FOR:  
520 FT - 520 FG - 520 GT - 520 LBP

 BOTTOM VIEW  
 Contact point

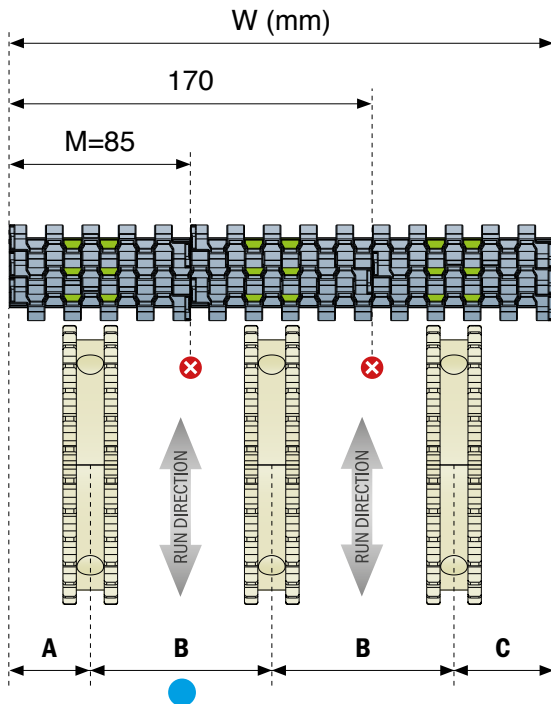

**A:** 38,25 mm    **B:** 85 mm (steps)    **C:** 46,75 mm

SPROCKETS POSITION FOR:  
520 FTT

 BOTTOM VIEW  
 Contact point

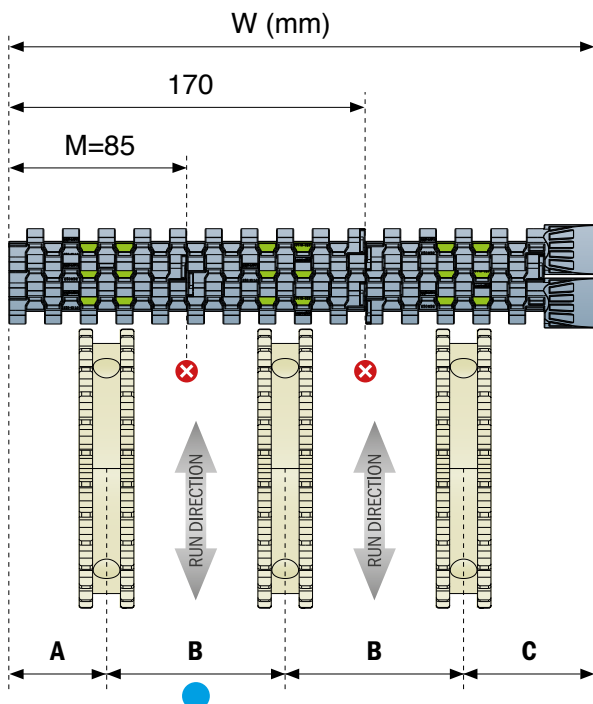



**A:** 46,75 mm    **B:** 85 mm (steps)    **C:** 62,25 mm

Belt width (mm)	Recommended n° of sprockets*
85	1
170	2
255	3
340	4
425	5
510	6
595	7
680	8
765	9
850	10
935	11
1020	12
1105	13
1190	14
1275	15
1360	16
1445	17
1530	18

\*If more sprockets are required contact application engineering.

### IMPORTANT

 Add sprocket positions every 85 mm according to 85 mm width increments of the belt corresponding with 85 mm conveyor track pitch system.

 It's **NOT** possible to place the sprockets in this position.

SPROCKETS POSITION FOR:  
**521 FT**

BOTTOM VIEW  
 Contact point

**K750 7,5" (190,5 mm)**

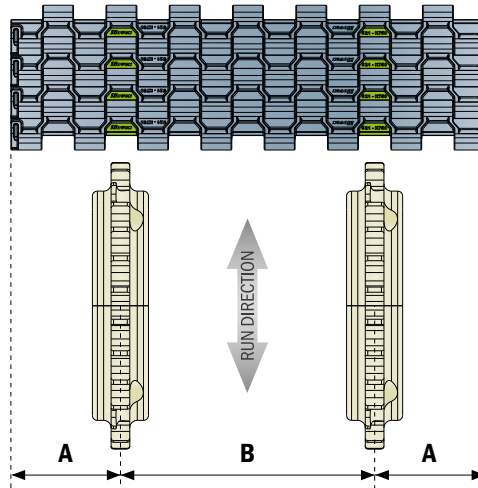

**A: 2,25" (57,15 mm)    B: 3" (76,2 mm /steps)**

Belt width (mm)	Recommended n° of sprockets*
100	2
150	3
200	4
250	5
300	6

\*If more sprockets are required contact application engineering.

**IMPORTANT**

Add sprocket positions every 50 mm according to 50 mm width increments of the belt corresponding with 50 mm conveyor track pitch system.

It's **NOT** possible to place the sprockets in this position.

SPROCKETS POSITION FOR:  
**522 HD FT**

BOTTOM VIEW  
 Contact point

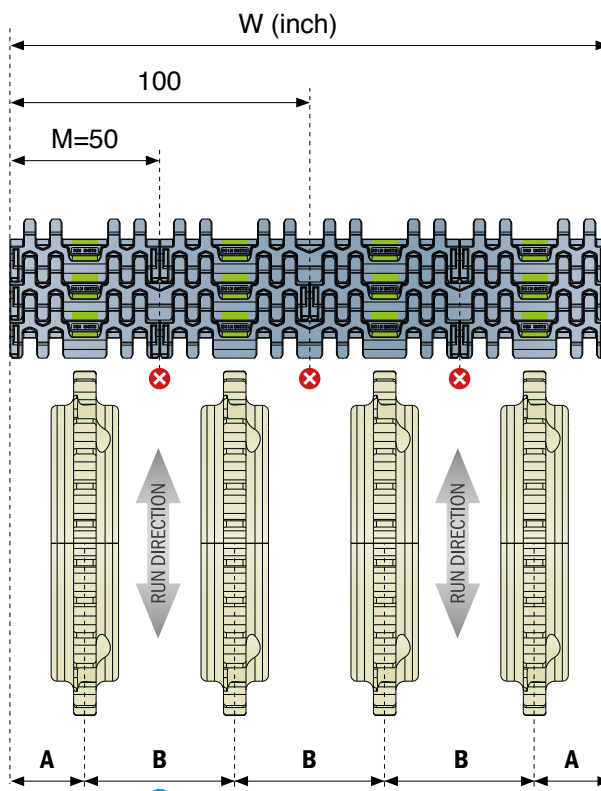

**A: 0,98" (25 mm)    B: 1,97" (50 mm /steps)**



## 2.1 Sprockets position | 522 HD - One track belt

SPROCKETS POSITION FOR:  
522 HD FT One track belt

 BOTTOM VIEW  
 Contact point

**K114**

1,14" (29 mm)

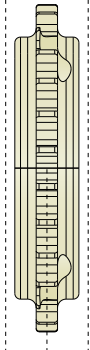

RUN DIRECTION

A A

A: 0,57"  
(14,5 mm)

**K134**

1,34" (34 mm)

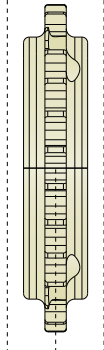

RUN DIRECTION

A A

A: 0,67"  
(17 mm)

**K146**

1,46" (37 mm)

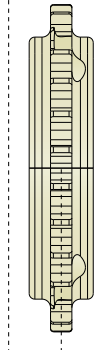

RUN DIRECTION

A A

A: 0,73"  
(18,5 mm)

**K200**

2,00" (51 mm)

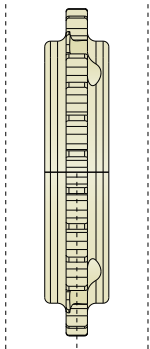
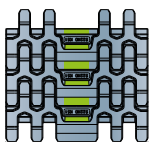

RUN DIRECTION

A A

A: 1,00"  
(25,5 mm)

**K300**

3,00" (76 mm)

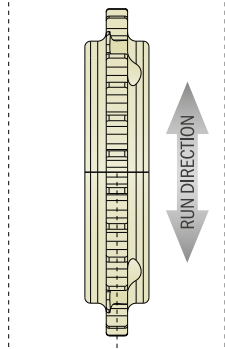
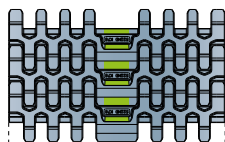

RUN DIRECTION

A A

A: 1,49"  
(38 mm)



**STRAIGHT**  
Running

Belt width (in/mm)	Recommended n° of sprockets*
3 / 76.2	1
6 / 152.4	2
9 / 228.6	3
12 / 304.5	4
15 / 381.0	5
18 / 457.2	6
21 / 533.4	7
24 / 609.6	8
27 / 685.8	9
30 / 762.0	10
33 / 838.2	11
36 / 914.4	12
39 / 990.6	13
42 / 1066.8	14
45 / 1143.0	15
48 / 1219.2	16
51 / 1295.4	17
54 / 1371.6	18

\*If more sprockets are required contact application engineering.

**IMPORTANT**

● Add sprocket positions every 76,2 mm according to 76,2 mm width increments of the belt corresponding with 76,2 mm conveyor track pitch system.

⊗ It's **NOT** possible to place the sprockets in this position.

**1 Gearmotor section**

Contact point

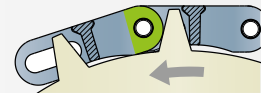

SPROCKETS POSITION FOR: 590 FT

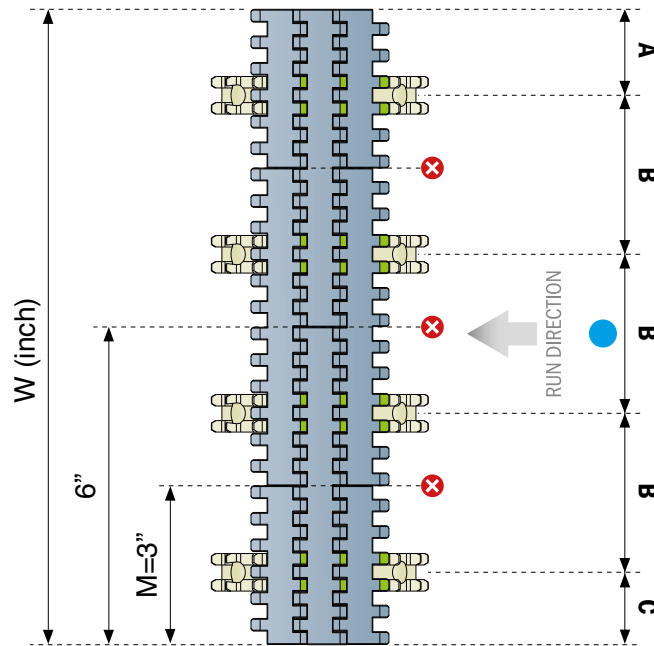

**A:** 1,62" (41,2 mm)    **B:** 3" (76,2 mm /steps)    **C:** 1,37" (34,9 mm)

**2 Return section**

Contact point

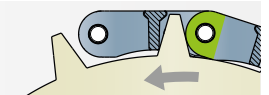

SPROCKETS POSITION FOR: 590 FT

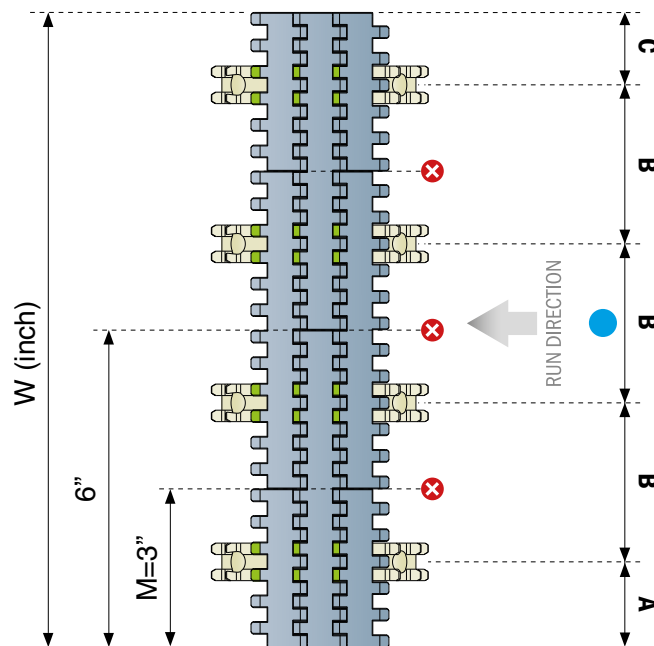

**A:** 1,62" (41,2 mm)    **B:** 3" (76,2 mm /steps)    **C:** 1,37" (34,9 mm)

**1 Gearmotor section**

Contact point

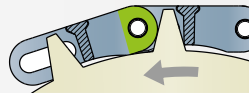

SPROCKETS POSITION FOR: 590 FT One track Belt

**K325 3,25" (82,55 mm)**

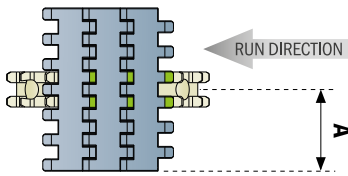

**A: 1,62" (41,2 mm)**

**K450 4,5" (114,3 mm)**

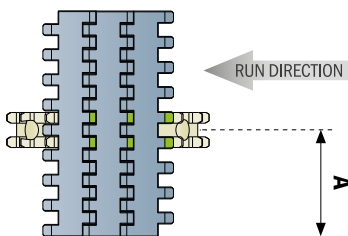

**A: 2,12" (54 mm)**

**K750 7,5" (190,5 mm)**

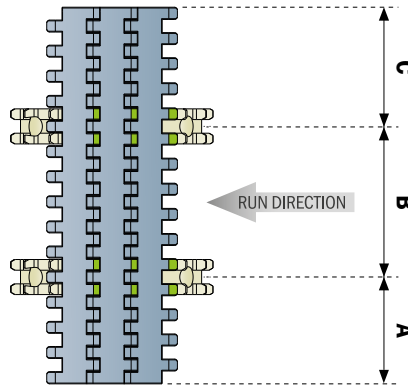

**A: 2,12" (54 mm)**

**B: 3" (76,2 mm)**

**C: 2,37" (60,3 mm)**

**STRAIGHT Running**

Belt width (in/mm)	Recommended n° of sprockets*
3 / 76.2	1
6 / 152.4	2
9 / 228.6	3
12 / 304.5	4
15 / 381.0	5
18 / 457.2	6
21 / 533.4	7
24 / 609.6	8
27 / 685.8	9
30 / 762.0	10
33 / 838.2	11
36 / 914.4	12
39 / 990.6	13
42 / 1066.8	14
45 / 1143.0	15
48 / 1219.2	16
51 / 1295.4	17
54 / 1371.6	18

\*If more sprockets are required contact application engineering.

**2 Return section**

Contact point

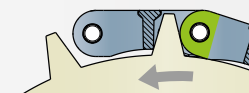

SPROCKETS POSITION FOR: 590 FT One track Belt

**K325 3,25" (82,55 mm)**

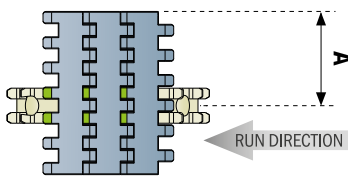

**A: 1,87" (47,55 mm)**

**K450 4,5" (114,3 mm)**

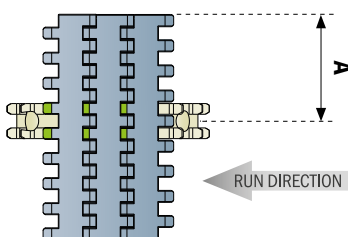

**A: 2,12" (54 mm)**

**K750 7,5" (190,5 mm)**

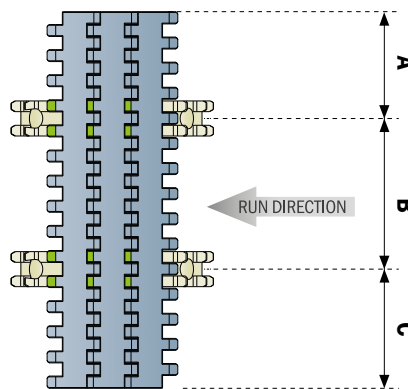

**A: 2,12" (54 mm)**

**B: 3" (76,2 mm)**

**C: 2,37" (60,3 mm)**

**IMPORTANT**

● Add sprocket positions every 76,2 mm according to 76,2 mm width increments of the belt corresponding with 76,2 mm conveyor track pitch system.



**STRAIGHT**  
Running

Belt width (in/mm)	Recommended n° of sprockets*
3 / 76.2	1
6 / 152.4	2
9 / 228.6	3
12 / 304.5	4
15 / 381.0	5
18 / 457.2	6
21 / 533.4	7
24 / 609.6	8
27 / 685.8	9
30 / 762.0	10
33 / 838.2	11
36 / 914.4	12
39 / 990.6	13
42 / 1066.8	14
45 / 1143.0	15
48 / 1219.2	16
51 / 1295.4	17
54 / 1371.6	18

\*If more sprockets are required contact application engineering.

**IMPORTANT**

● Add sprocket positions every 76,2 mm according to 76,2 mm width increments of the belt corresponding with 76,2 mm conveyor track pitch system.

**1 Gearmotor section**

Contact point

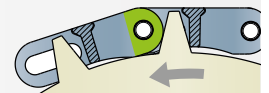

SPROCKETS POSITION FOR: 590 FTT

**K450 4,5" (114,3 mm)**

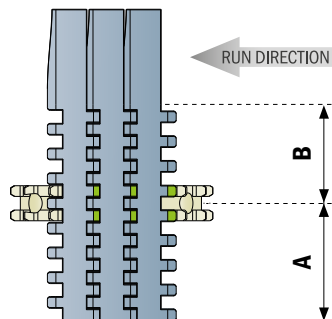

**A min: 2,37" (60,3 mm)**  
**B min: 2" (50,8 mm)**

**K750 7,5" (190,5 mm)**

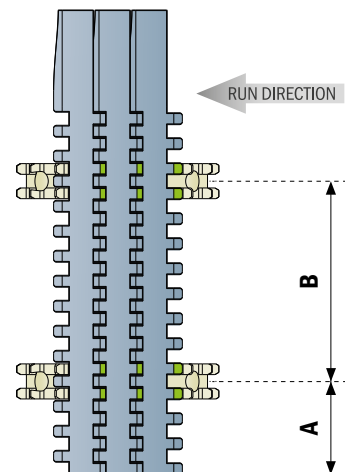

**A min: 1,87" (47,55 mm)**  
**B min: 4" (101,6 mm)**

**2 Return section**

Contact point

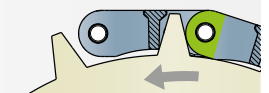

SPROCKETS POSITION FOR: 590 FTT

**K450 4,5" (114,3 mm)**

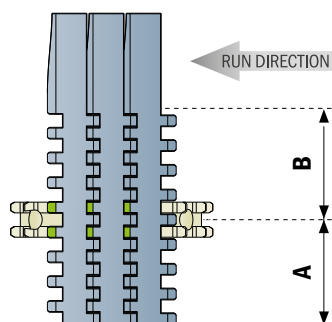

**A min: 2,12" (54 mm)**  
**B min: 2,12" (54 mm)**

**K750 7,5" (190,5 mm)**

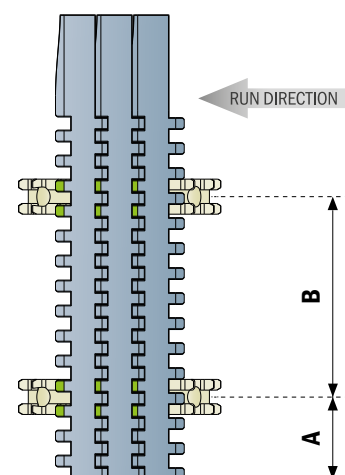

**A min: 1,62" (41,2 mm)**  
**B min: 4" (101,6 mm)**

## 2.1 Sprockets position | 525 Series

SPROCKETS POSITION FOR:  
525 HD FT - 525 HD FG - 525 HD GT - 525 HD GTsi

 BOTTOM VIEW  
 Contact point

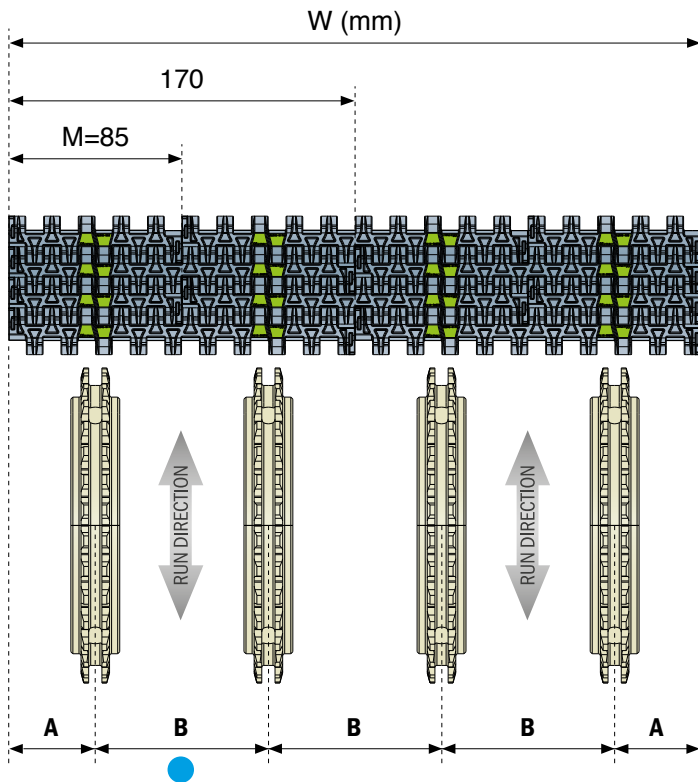

**A minimum: 42,5 mm**

**B minimum: 85 mm (steps)**

SPROCKETS POSITION FOR:  
525 FTT

 BOTTOM VIEW  
 Contact point

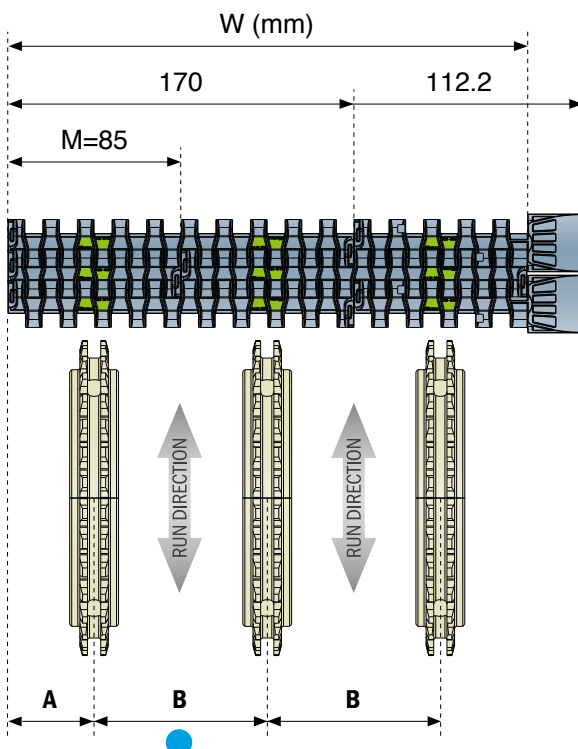

**A minimum: 42,5 mm**

**B minimum: 85 mm (steps)**

Belt width (mm)	Recommended n° of sprockets*
85	1
170	2
255	3
340	4
425	5
510	6
595	7
680	8
765	9
850	10
935	11
1020	12
1105	13
1190	14
1275	15
1360	16
1445	17
1530	18

\*If more sprockets are required contact application engineering.

### IMPORTANT

 Add sprocket positions every 85 mm according to 85 mm width increments of the belt corresponding with 85 mm conveyor track pitch system.

## 2.1 Sprockets position | 530 Series

Belt width (in/mm)	Recommended n° of sprockets*
3 / 76.2	1
6 / 152.4	2
9 / 228.6	3
12 / 304.5	4
15 / 381.0	5
18 / 457.2	6
21 / 533.4	7
24 / 609.6	8
27 / 685.8	9
30 / 762.0	10
33 / 838.2	11
36 / 914.4	12
39 / 990.6	13
42 / 1066.8	14
45 / 1143.0	15
48 / 1219.2	16
51 / 1295.4	17
54 / 1371.6	18

\*If more sprockets are required contact application engineering.

SPROCKETS POSITION FOR:

530 FT - 530 GT - 530 GTsi - 530 LBP - 530 Pro LBP

BOTTOM VIEW  
Contact point

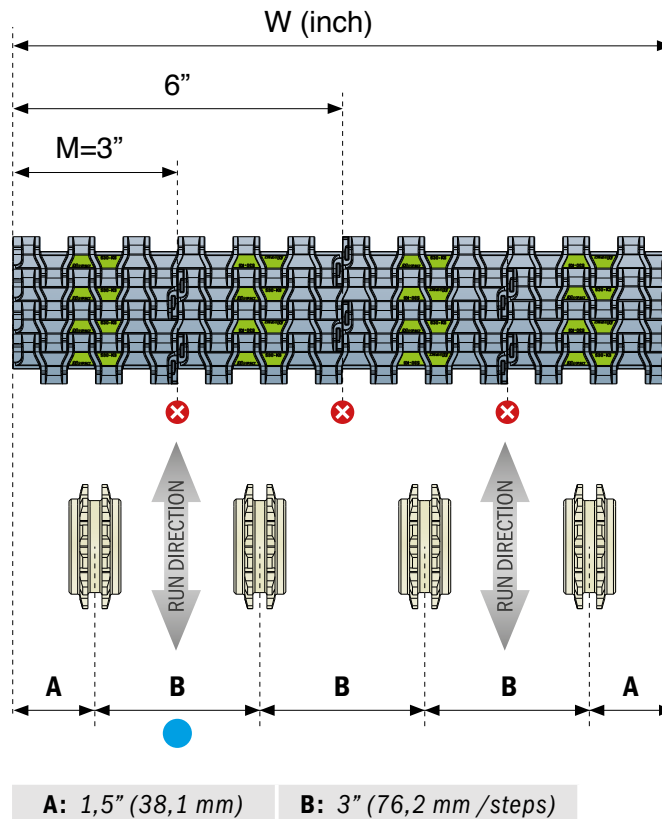

SPROCKETS POSITION FOR:

530 FTT

BOTTOM VIEW  
Contact point

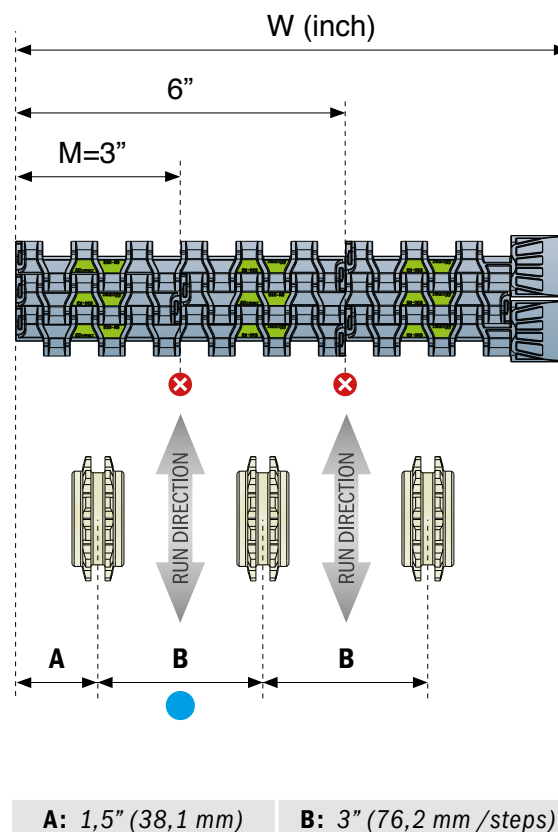

### IMPORTANT

● Add sprocket positions every 76,2 mm according to 76,2 mm width increments of the belt corresponding with 76,2 mm conveyor track pitch system.

⊗ It's **NOT** possible to place the sprockets in this position.

## 2.1 Sprockets position | 550 Series

SPROCKETS POSITION FOR:

**550 FT - 550 FLIGHTOP - 550 FG - 550 GT - 550 GTsi**

BOTTOM VIEW

**Contact point**

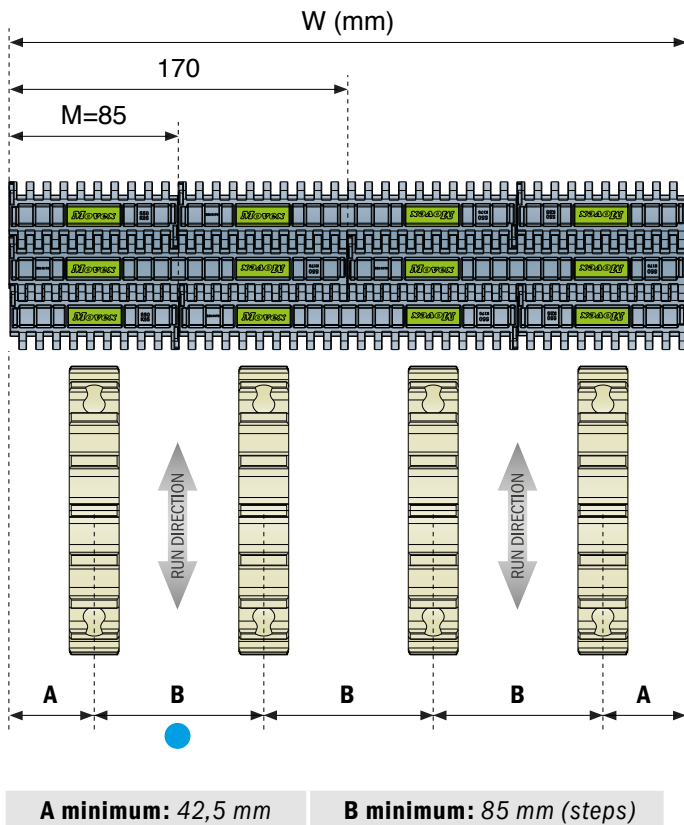

Belt width (mm)	Recommended n° of sprockets*
85	1
170	2
255	3
340	4
425	5
510	6
595	7
680	8
765	9
850	10
935	11
1020	12
1105	13
1190	14
1275	15
1360	16
1445	17
1530	18

\*If more sprockets are required contact application engineering.

SPROCKETS POSITION FOR:

**550 FTT**

BOTTOM VIEW

**Contact point**

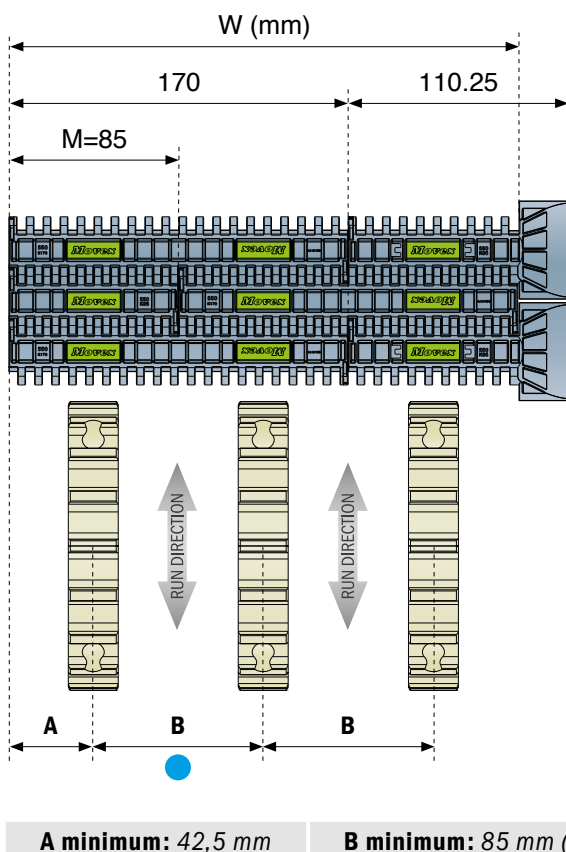

### IMPORTANT

Add sprocket positions every 85 mm according to 85 mm width increments of the belt corresponding with 85 mm conveyor track pitch system.

## 2.1 Sprockets position | 551 Series

Belt width (mm)	Recommended n° of sprockets*
85	1
170	2
255	3
340	4
425	5
510	6
595	7
680	8
765	9
850	10
935	11
1020	12
1105	13
1190	14
1275	15
1360	16
1445	17
1530	18

\*If more sprockets are required contact application engineering.

SPROCKETS POSITION FOR:

551 FT - 551 GT - 551 GTsi - 551 LBP - 551 PRO LBP

BOTTOM VIEW

Contact point

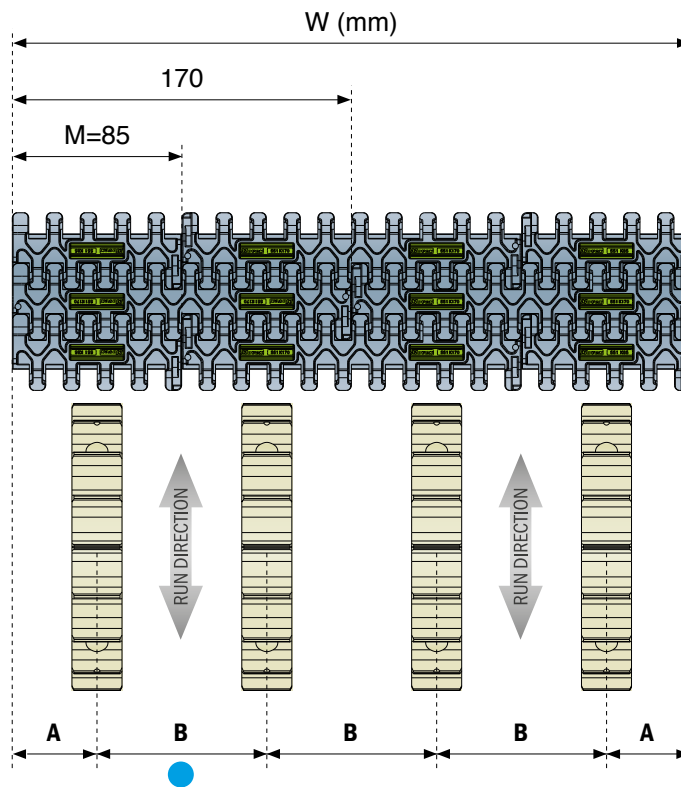

A minimum: 42,5 mm

B minimum: 85 mm (steps)

SPROCKETS POSITION FOR:

551 FTT

BOTTOM VIEW

Contact point

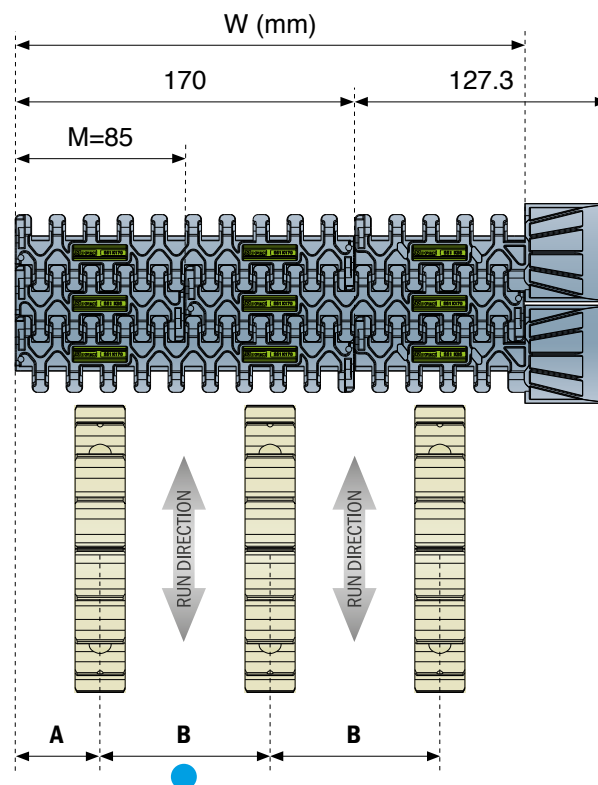

A minimum: 42,5 mm

B minimum: 85 mm (steps)

### IMPORTANT

Add sprocket positions every 85 mm according to 85 mm width increments of the belt corresponding with 85 mm conveyor track pitch system.



## 2.1 Sprockets position | 552 Series

SPROCKETS POSITION FOR:  
552 FT - 552 PT - 552 GT - 552 GTsi

👁️ BOTTOM VIEW  
● Contact point

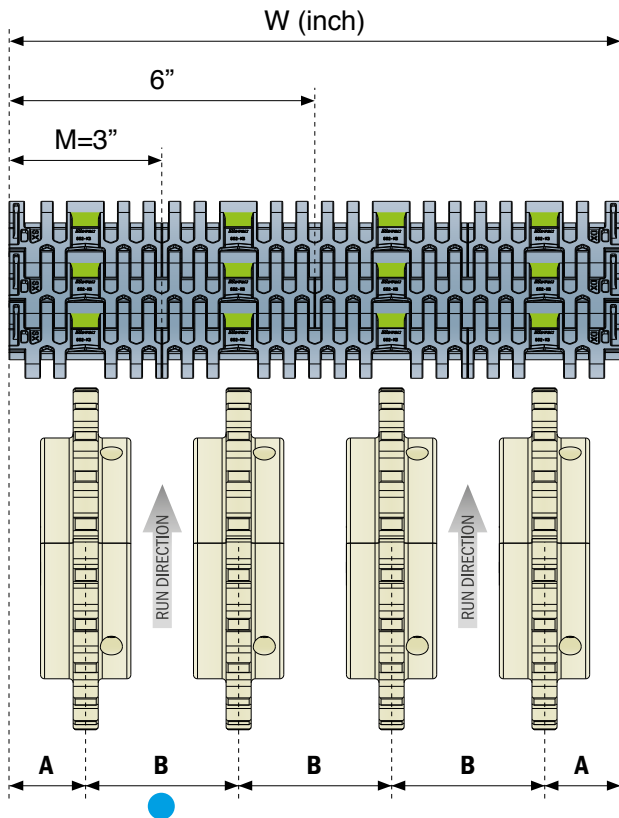

**A minimum: 1,5" (38,1 mm)**

**B minimum: 3" (76,2 mm)**

Belt width (in/mm)	Recommended n° of sprockets*
3 / 76.2	1
6 / 152.4	2
9 / 228.6	3
12 / 304.5	4
15 / 381.0	5
18 / 457.2	6
21 / 533.4	7
24 / 609.6	8
27 / 685.8	9
30 / 762.0	10
33 / 838.2	11
36 / 914.4	12
39 / 990.6	13
42 / 1066.8	14
45 / 1143.0	15
48 / 1219.2	16
51 / 1295.4	17
54 / 1371.6	18

\*If more sprockets are required contact application engineering.

### ENGAGEMENT ZOOM

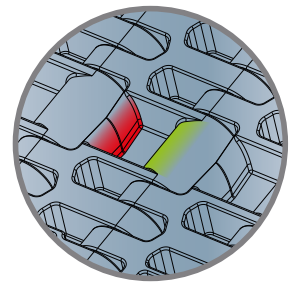

Correct contact point

Wrong contact point

### IMPORTANT

● Add sprocket positions every 76,2 mm according to 76,2 mm width increments of the belt corresponding with 76,2 mm conveyor track pitch system.

SPROCKETS POSITION FOR:  
552 FT One track belt

BOTTOM VIEW  
 Contact point

ENGAGEMENT  
ZOOM

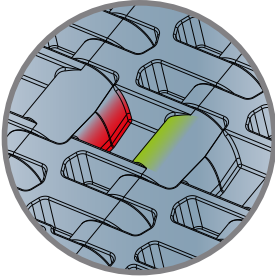

Correct contact point  
Wrong contact point

**K325**  
3,25" (82,55 mm)

**K450**  
4,5" (114,3 mm)

**K750**  
7,5" (190,5 mm)

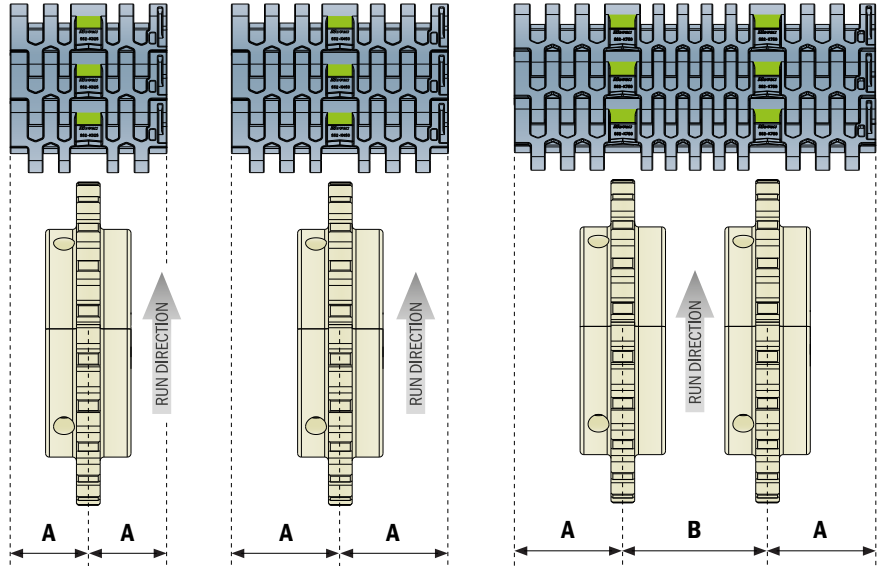

**A: 1,62"**  
**(41,3 mm)**

**A: 2,25"**  
**(57,15 mm)**

**A: 2,25" (57,15 mm)**  
**B: 3" (76,2 mm)**

SPROCKETS POSITION FOR:  
552 FTT

BOTTOM VIEW  
 Contact point

ENGAGEMENT  
ZOOM

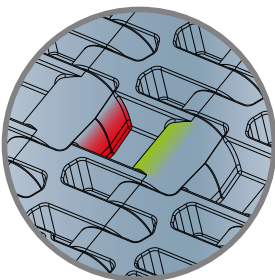

Correct contact point  
Wrong contact point

**K450**  
4,5" (114,3 mm)

**K750**  
7,5" (190,5 mm)

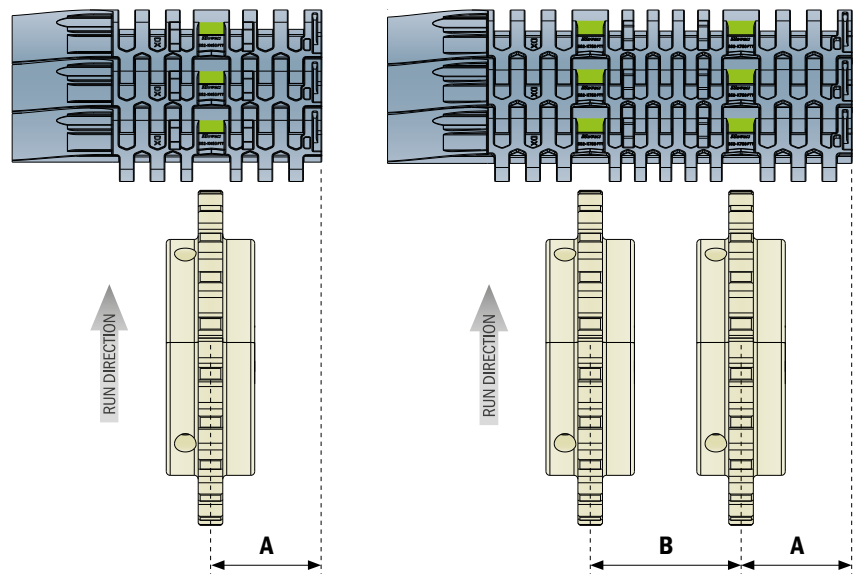

**A: 2,25" (57,15 mm)**

**A: 2,25" (57,15 mm)**

**B: 3" (76,2 mm)**

## 2.1 Sprockets position | 553 Series

### SPROCKETS POSITION FOR: 553 FLEXTOP

👁️ BOTTOM VIEW  
● Contact point

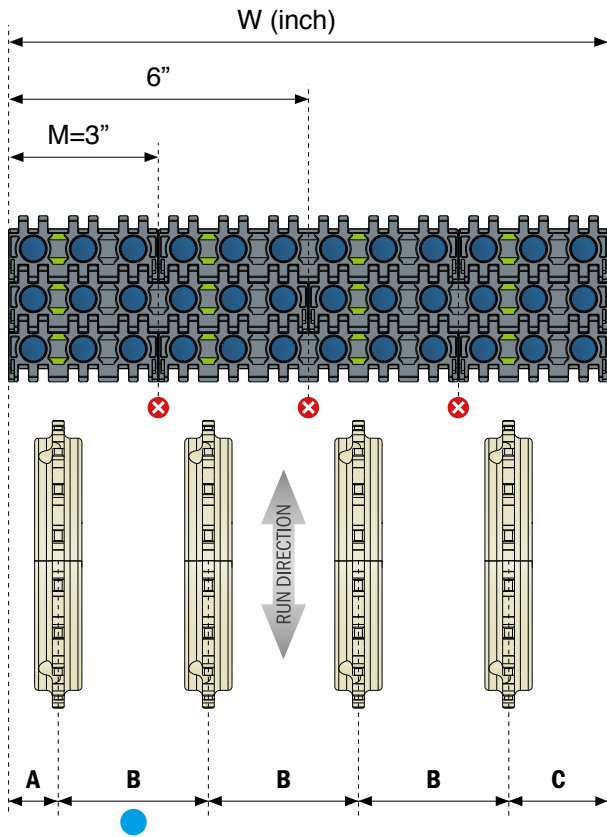

Belt width (in/mm)	Recommended n° of sprockets
3 / 76.2	1
6 / 152.4	2
9 / 228.6	3
12 / 304.5	4
15 / 381.0	5
18 / 457.2	6
21 / 533.4	7
24 / 609.6	8
27 / 685.8	9
30 / 762.0	10
33 / 838.2	11
36 / 914.4	12
39 / 990.6	13
42 / 1066.8	14
45 / 1143.0	15
48 / 1219.2	16
51 / 1295.4	17
54 / 1371.6	18

### HEAVY DUTY SPROCKETS POSITION FOR: 553 FLEXTOP

👁️ BOTTOM VIEW  
● Contact point

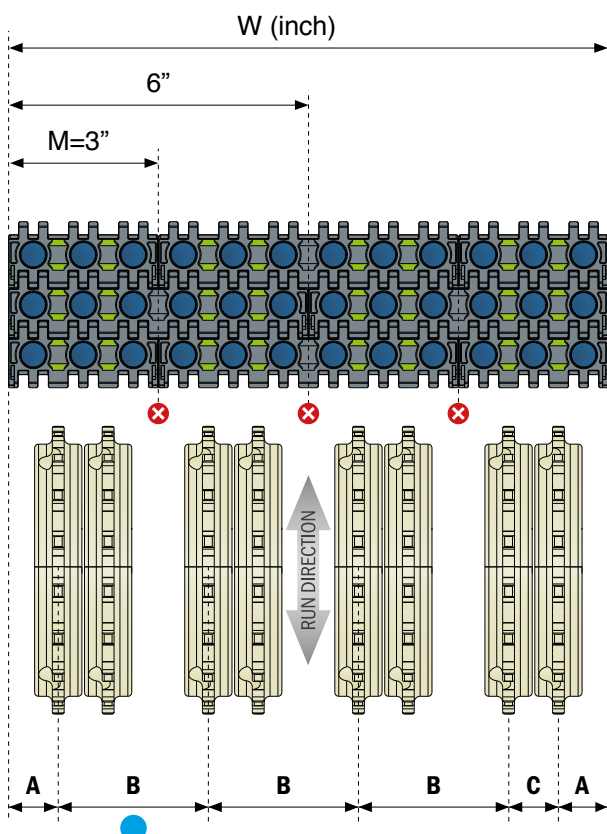

### IMPORTANT

● Add sprocket positions every 76,2 mm according to 76,2 mm width increments of the belt corresponding with 76,2 mm conveyor track pitch system.

✗ It's **NOT** possible to place the sprockets in this position.

If more sprockets are required the **HEAVY DUTY** position can be followed.

**HEAVY DUTY** position is ideal in case the load of the application is close to the belt limit or in case there is an high number of starts/stops during production.

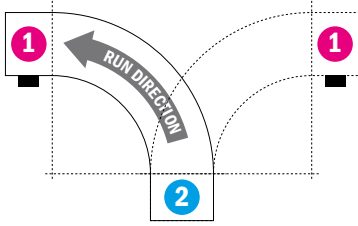

**LEFT and RIGHT Version**

Belt width (In/mm)	Recommended n° of sprockets*
6 / 152.4	2
9 / 228.6	3
12 / 304.5	4
15 / 381.0	5
18 / 457.2	6
21 / 533.4	7
24 / 609.6	8

\*If more sprockets are required contact application engineering.

**1 Gearmotor section**

Contact point

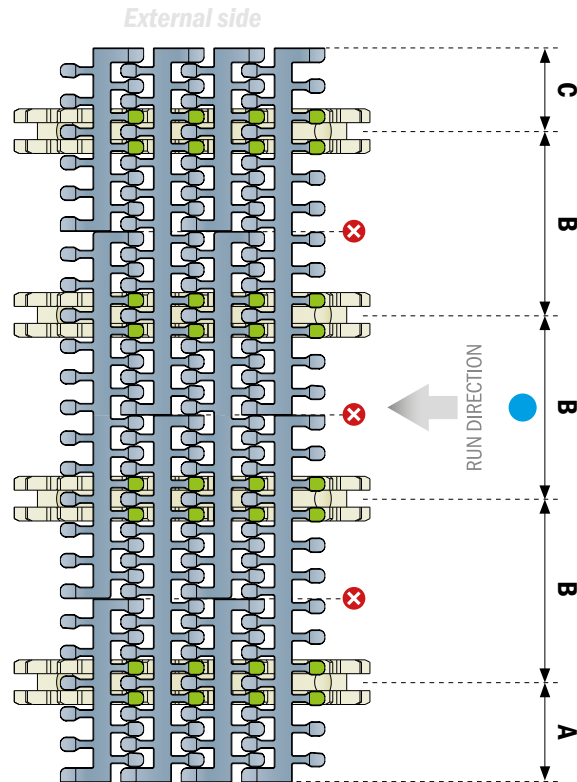
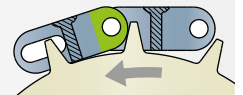

**2 Return section**

Contact point

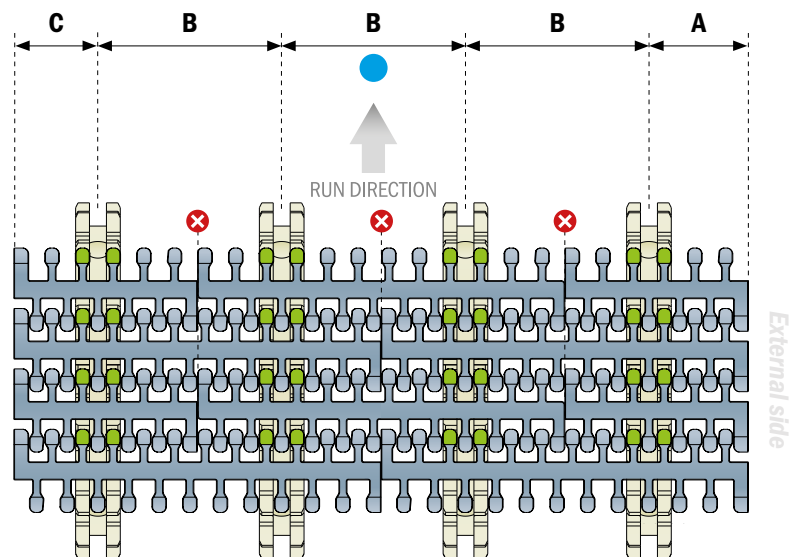

**IMPORTANT**

Sprockets teeth must press against the hinge loops, never against the module's central bridge in the gap between the hinge loops.

● Add sprocket positions every 85 mm according to 85 mm width increments of the belt corresponding with 85 mm conveyor track pitch system.

✗ It's **NOT** possible to place the sprockets in this position.

A min: 35,1 mm

B min: 76,2 mm

C min: 41,1 mm

**1 Gearmotor section**

Contact point

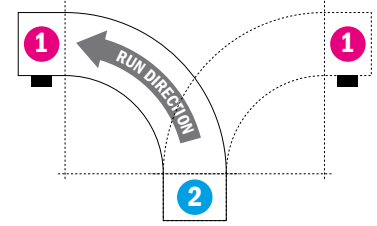
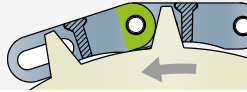

**LEFT and RIGHT Version**

Belt width (mm)	Recommended n° of sprockets*
255	3
340	4
425	5
510	6
595	7
680	8
765	9
850	10

\* Configuration valid for drive and idler section.

If more sprockets are required contact application engineering.

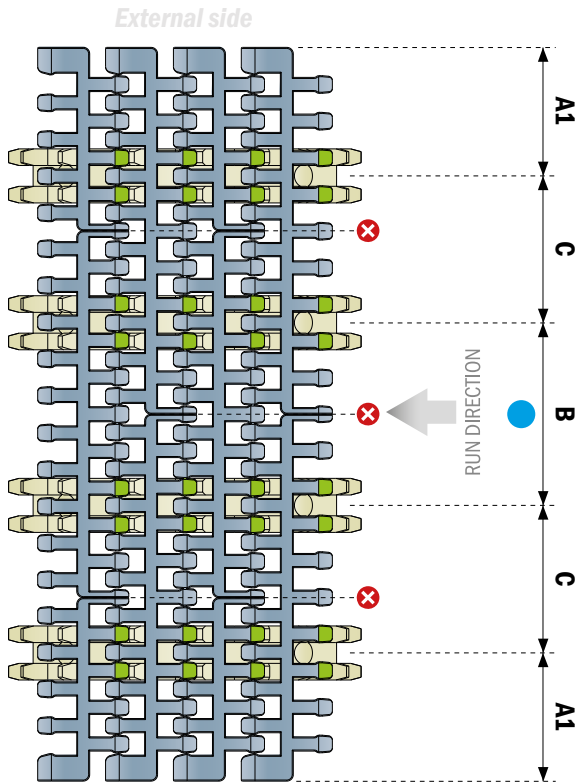

**2 Return section**

Contact point

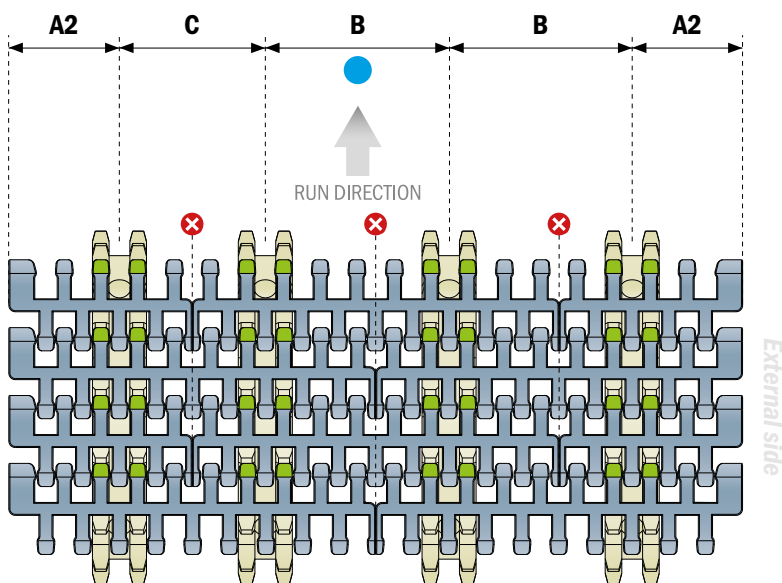
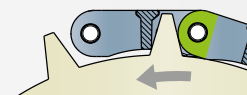

**IMPORTANT**

Sprockets teeth must press against the hinge loops, never against the module's central bridge in the gap between the hinge loops.

● Add sprocket positions every 85 mm according to 85 mm width increments of the belt corresponding with 85 mm conveyor track pitch system.

✗ It's **NOT** possible to place the sprockets in this position.

<b>A1:</b> 59,5 mm	<b>A2:</b> 51 mm	<b>B:</b> 85 mm	<b>C:</b> 68 mm
--------------------	------------------	-----------------	-----------------

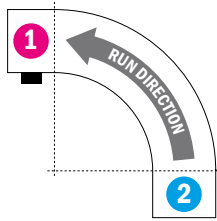

**LEFT Version**

Belt width (mm)	Recommended n° of sprockets*
340	4
425	5
510	6
595	7
680	8
765	9
850	10

\* Configuration valid for drive and idler section.

If more sprockets are required contact application engineering.

**1 Gearmotor section**

Contact point

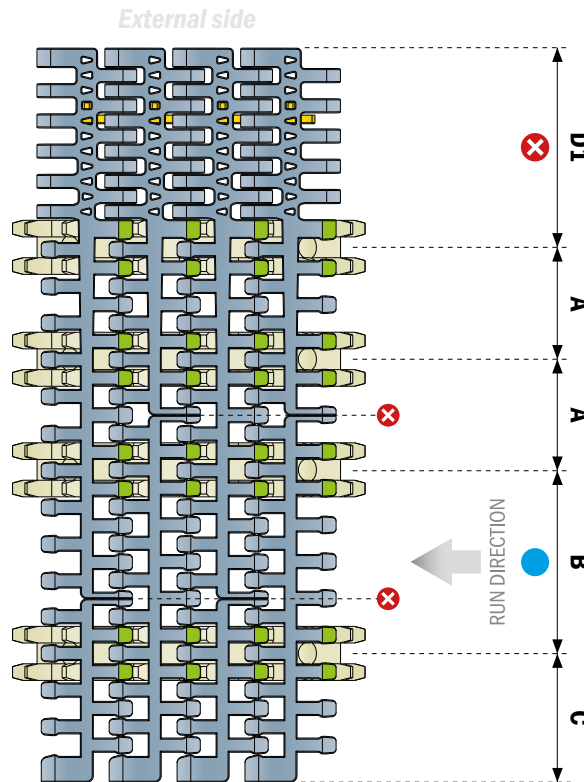
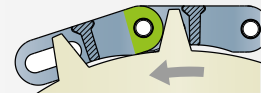

**2 Return section**

Contact point

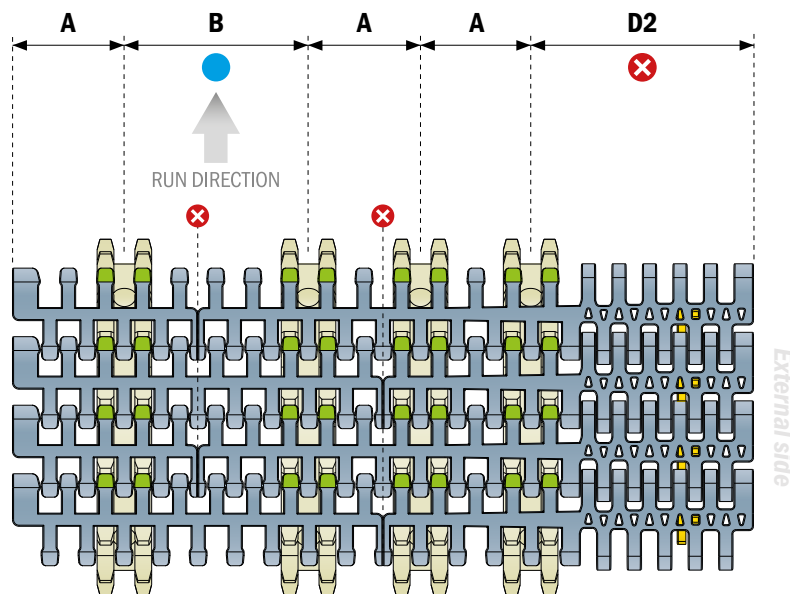
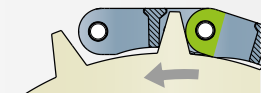

**IMPORTANT**

Sprockets teeth must press against the hinge loops, never against the module's central bridge in the gap between the hinge loops.

● Add sprocket positions every 85 mm according to 85 mm width increments of the belt corresponding with 85 mm conveyor track pitch system.

✗ It's **NOT** possible to place the sprockets in this position.

<b>A:</b> 51 mm	<b>B:</b> 85 mm	<b>C:</b> 59.5 mm
<b>D1:</b> 93.5 mm	<b>D2:</b> 102 mm	

**1 Gearmotor section**

Contact point

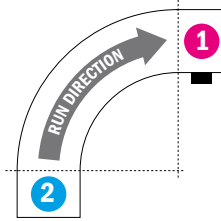
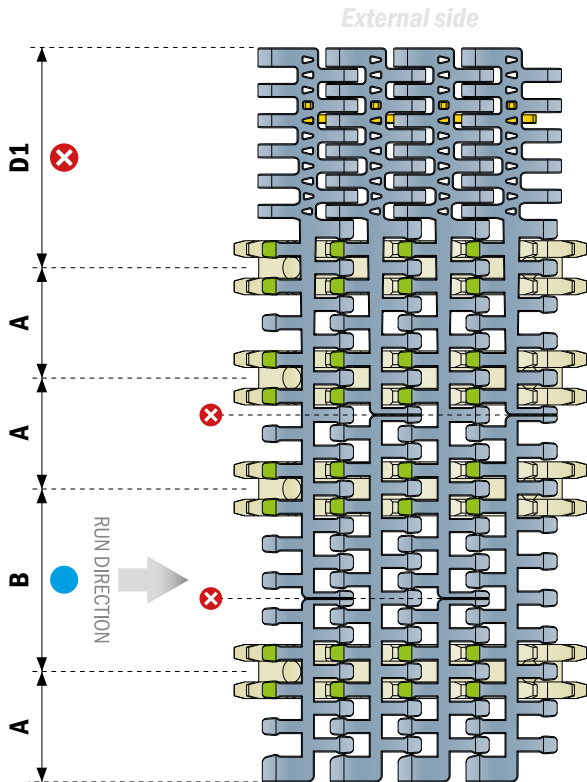
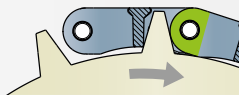

**RIGHT Version**

Belt width (mm)	Recommended n° of sprockets*
340	4
425	5
510	6
595	7
680	8
765	9
850	10

\* Configuration valid for drive and idler section.

If more sprockets are required contact application engineering.

**2 Return section**

Contact point

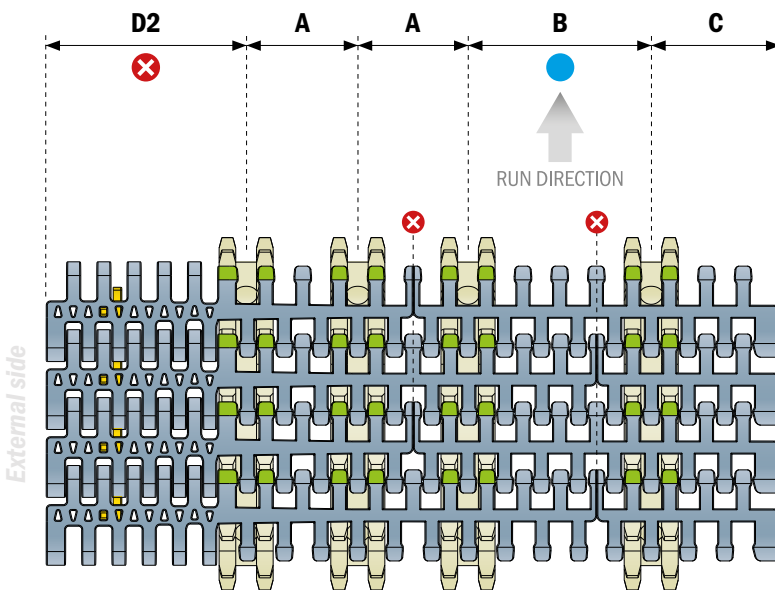
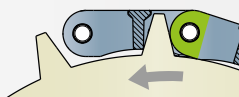

**IMPORTANT**

Sprockets teeth must press against the hinge loops, never against the module's central bridge in the gap between the hinge loops.

● Add sprocket positions every 85 mm according to 85 mm width increments of the belt corresponding with 85 mm conveyor track pitch system.

✗ It's **NOT** possible to place the sprockets in this position.

<b>A:</b> 51 mm	<b>B:</b> 85 mm	<b>C:</b> 59.5 mm
<b>D1:</b> 102 mm	<b>D2:</b> 93.5 mm	

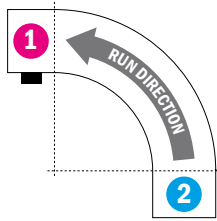

**LEFT Version**

Belt width (mm)	Recommended n° of sprockets*
340	5
425	6
510	7
595	8
680	9
765	10
850	11

\* Configuration valid for drive and idler section.

If more sprockets are required contact application engineering.

**1 Gearmotor section**

Contact point

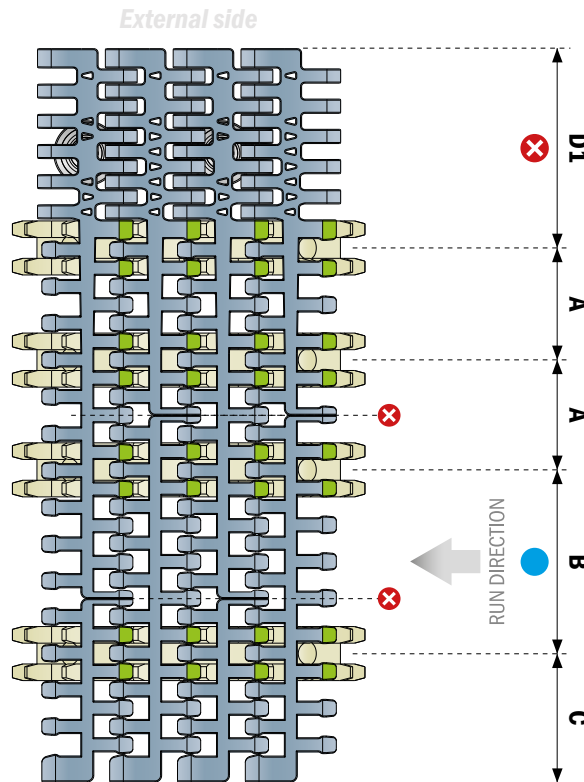
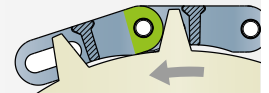

**2 Return section**

Contact point

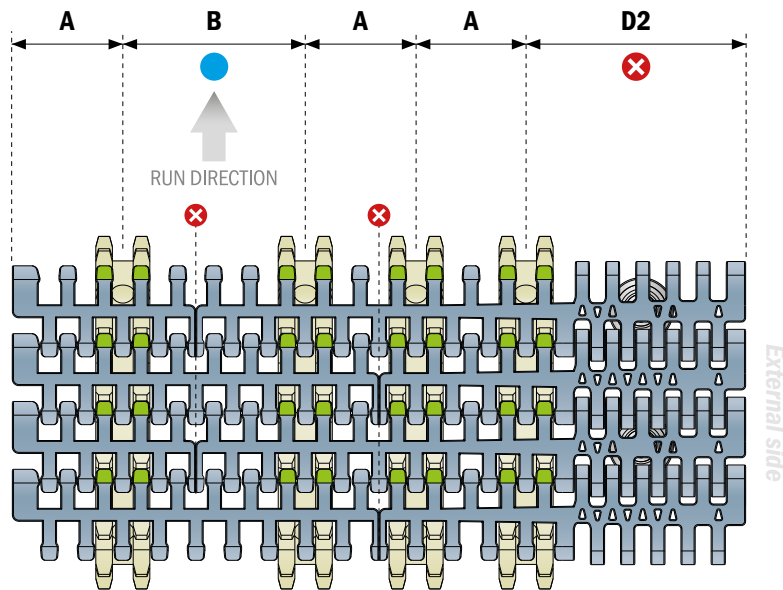
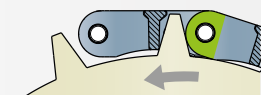

**IMPORTANT**

Sprockets teeth must press against the hinge loops, never against the module's central bridge in the gap between the hinge loops.

● Add sprocket positions every 85 mm according to 85 mm width increments of the belt corresponding with 85 mm conveyor track pitch system.

✗ It's **NOT** possible to place the sprockets in this position.

<b>A:</b> 51 mm	<b>B:</b> 85 mm	<b>C:</b> 59.5 mm
<b>D1:</b> 93.5 mm	<b>D2:</b> 102 mm	



**1 Gearmotor section**

Contact point

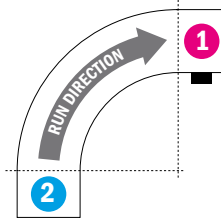
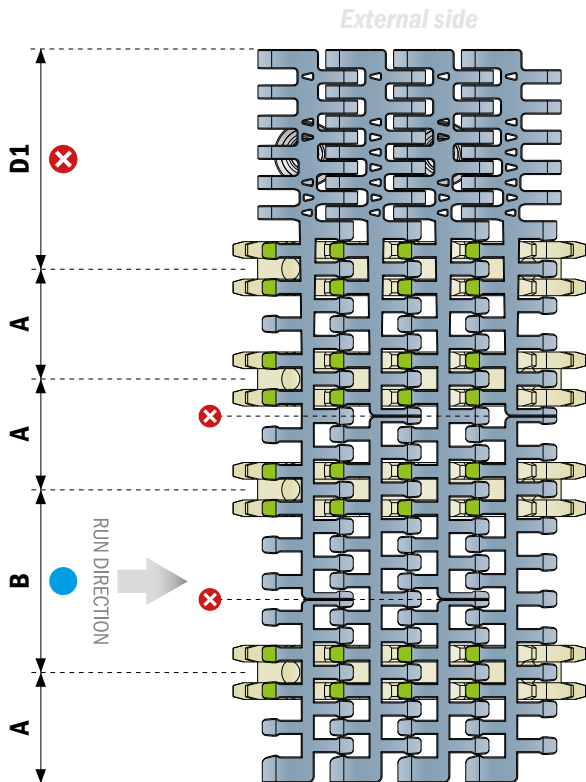
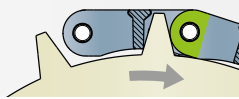

**RIGHT**  
Version

Belt width (mm)	Recommended n° of sprockets*
340	5
425	6
510	7
595	8
680	9
765	10
850	11

\* Configuration valid for drive and idler section.

If more sprockets are required contact application engineering.

**2 Return section**

Contact point

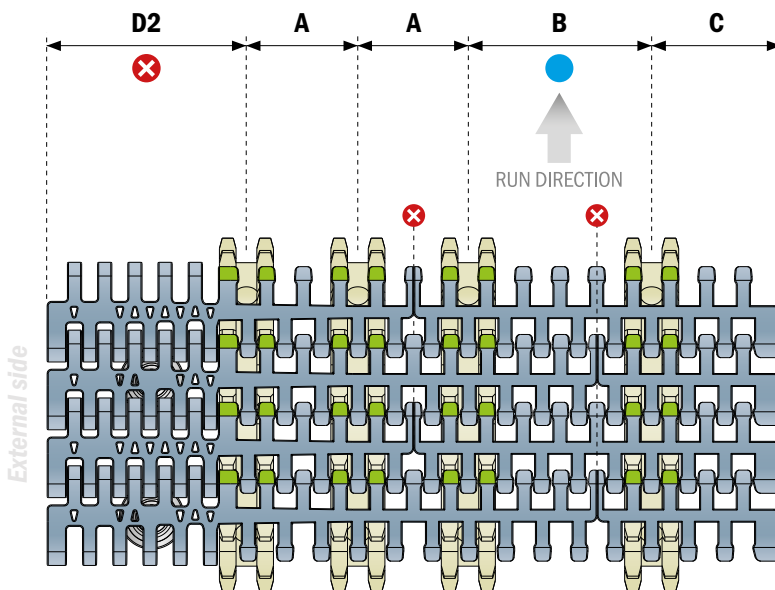
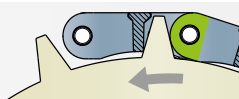

**IMPORTANT**

Sprockets teeth must press against the hinge loops, never against the module's central bridge in the gap between the hinge loops.

● Add sprocket positions every 85 mm according to 85 mm width increments of the belt corresponding with 85 mm conveyor track pitch system.

✗ It's **NOT** possible to place the sprockets in this position.

<b>A:</b> 51 mm	<b>B:</b> 85 mm	<b>C:</b> 59.5 mm
<b>D1:</b> 102 mm	<b>D2:</b> 93.5 mm	

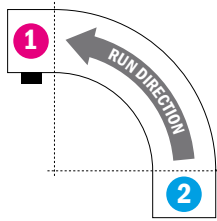

**LEFT  
Version**

Belt width (mm)	Recommended n° of sprockets*
340	5
425	6
510	7
595	8
680	9
765	10
850	11

\* Configuration valid for drive and idler section.

If more sprockets are required contact application engineering.

**1 Gearmotor section**

Contact point

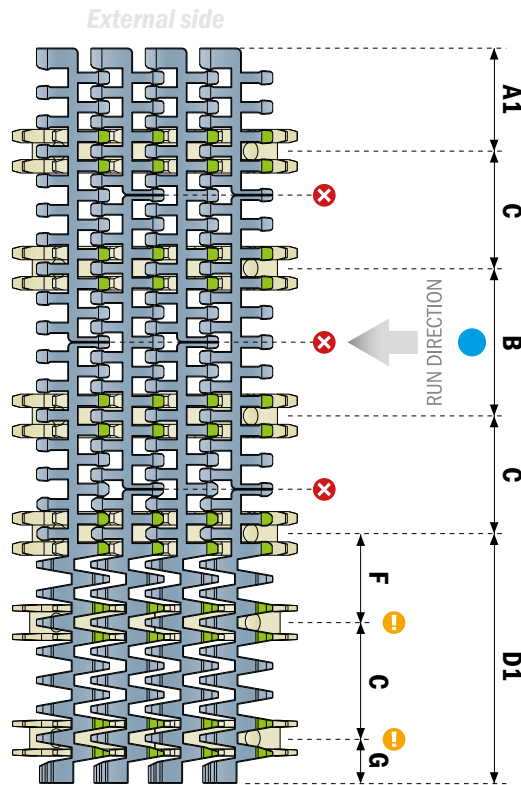
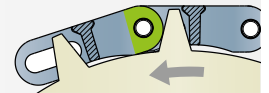

**IMPORTANT**

Sprockets teeth must press against the hinge loops, never against the module's central bridge in the gap between the hinge loops.

● Add sprocket positions every 85 mm according to 85 mm width increments of the belt corresponding with 85 mm conveyor track pitch system.

⊗ It's **NOT** possible to place the sprockets in this position.

**Small radius section support options:**



**Support sprocket**  
info and order code  
Pag 48



**Split support roller**  
info and order code  
Pag 48

**2 Return section**

Contact point

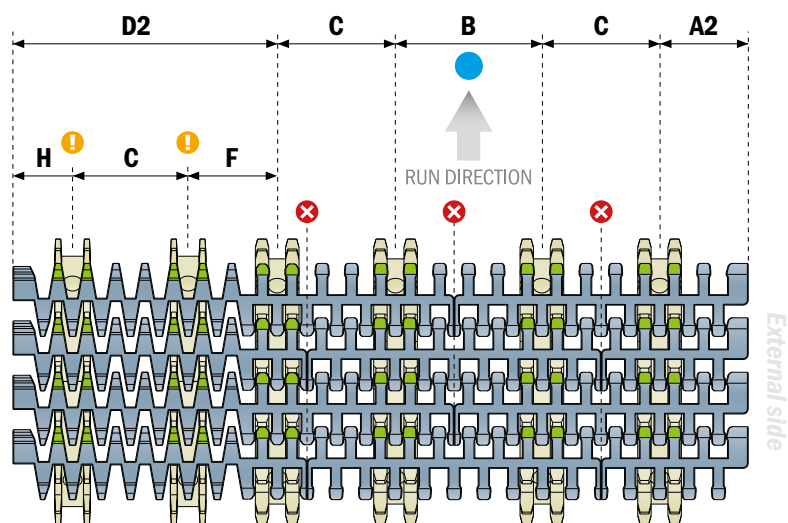
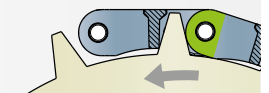

<b>A1:</b> 59.5 mm	<b>A2:</b> 51 mm	<b>B:</b> 85 mm	<b>C:</b> 68 mm	<b>D1:</b> 144.5 mm
<b>D2:</b> 153 mm	<b>F:</b> 50.5 mm	<b>G:</b> 26 mm	<b>H:</b> 34.5 mm	

**1 Gearmotor section**

Contact point

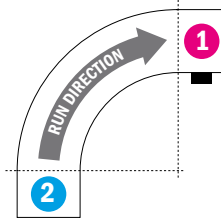
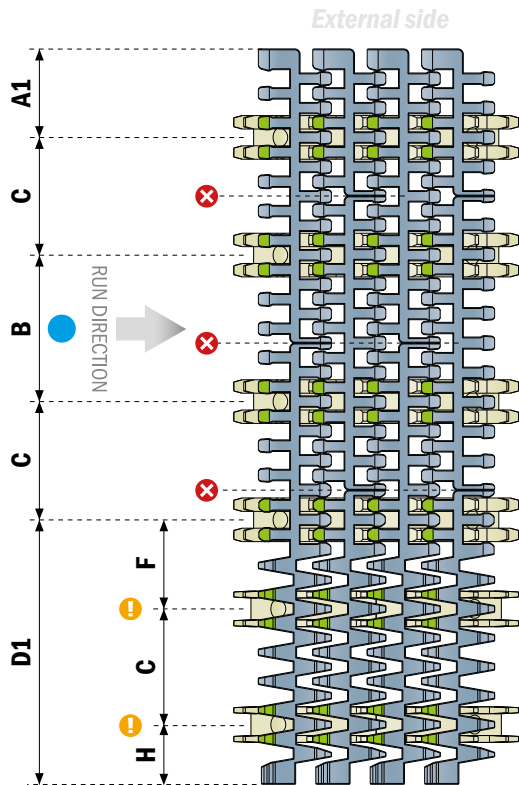
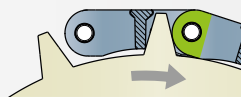

**RIGHT Version**

Belt width (mm)	Recommended n° of sprockets*
340	5
425	6
510	7
595	8
680	9
765	10
850	11

\* Configuration valid for drive and idler section.

If more sprockets are required contact application engineering.

**2 Return section**

Contact point

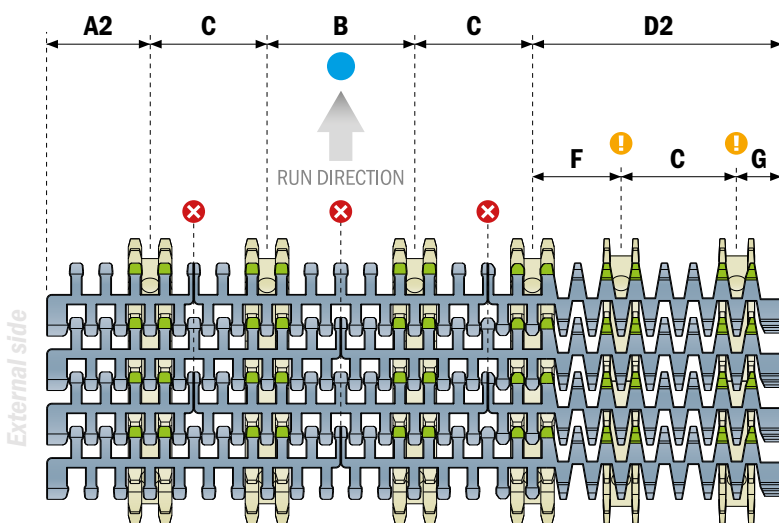
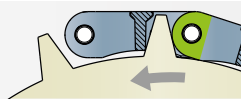

**IMPORTANT**

Sprockets teeth must press against the hinge loops, never against the module's central bridge in the gap between the hinge loops.

● Add sprocket positions every 85 mm according to 85 mm width increments of the belt corresponding with 85 mm conveyor track pitch system.

✗ It's **NOT** possible to place the sprockets in this position.

! **Small radius section support options:**



**Support sprocket**  
info and order code  
Pag 48



**Split support roller**  
info and order code  
Pag 48

A1: 51 mm	A2: 59.5 mm	B: 85 mm	C: 68 mm	D1: 153 mm
D2: 144.5 mm	F: 50.5 mm	G: 26 mm	H: 34.5 mm	

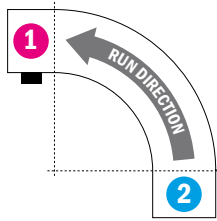

**LEFT**  
Version

Belt width (mm)	Recommended n° of sprockets*
340	5
425	6
510	7
595	8
680	9
765	10
850	11

\* Configuration valid for drive and idler section.

If more sprockets are required contact application engineering.

**IMPORTANT**

Sprockets teeth must press against the hinge loops, never against the module's central bridge in the gap between the hinge loops.

● Add sprocket positions every 85 mm according to 85 mm width increments of the belt corresponding with 85 mm conveyor track pitch system.

⊗ It's **NOT** possible to place the sprockets in this position.

! **Small radius section support options:**



**Support sprocket**  
info and order code  
Pag 48



**Split support roller**  
info and order code  
Pag 48

**1 Gearmotor section**

Contact point

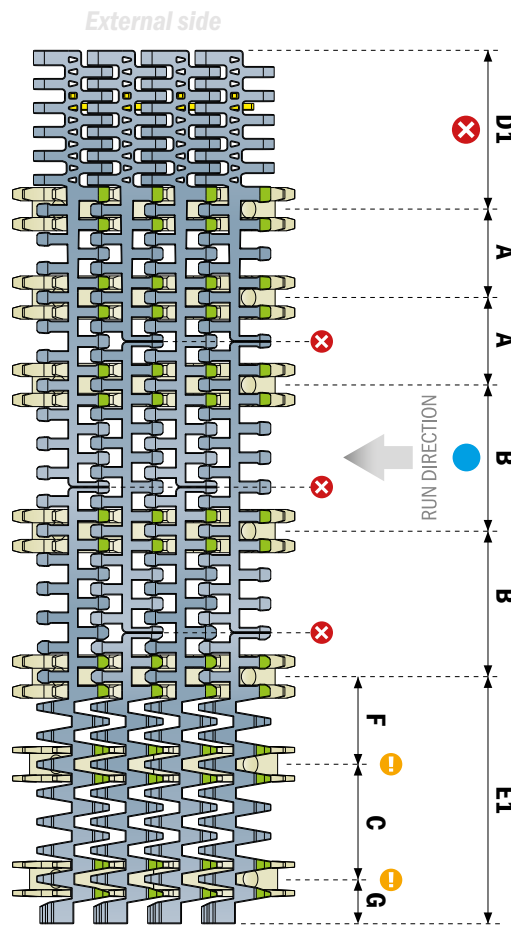
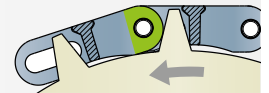

**2 Return section**

Contact point

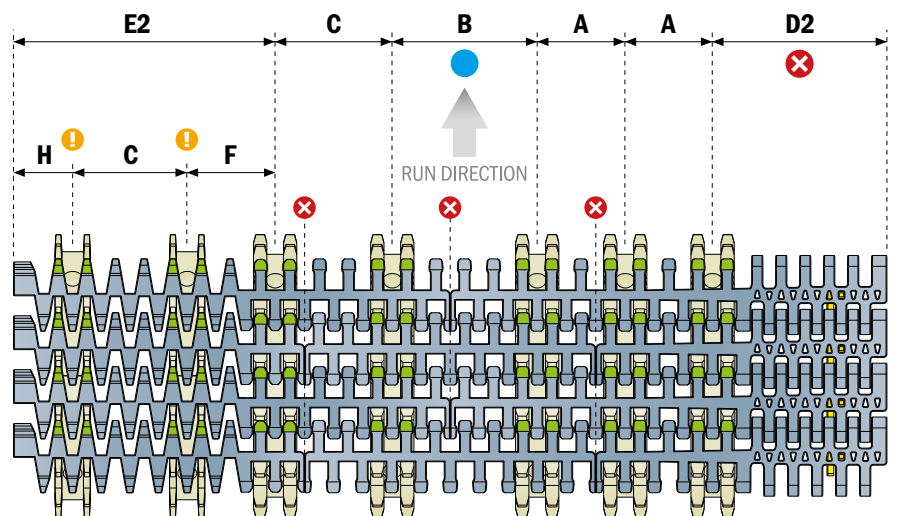
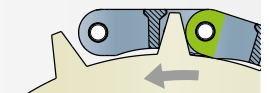

<b>A:</b> 51 mm	<b>B:</b> 85 mm	<b>C:</b> 68 mm	<b>D1:</b> 93.5 mm	<b>D2:</b> 102 mm
<b>E1:</b> 144.5 mm	<b>E2:</b> 153 mm	<b>F:</b> 50.5 mm	<b>G:</b> 26 mm	<b>H:</b> 34.5 mm

**1 Gearmotor section**

Contact point

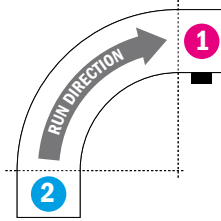
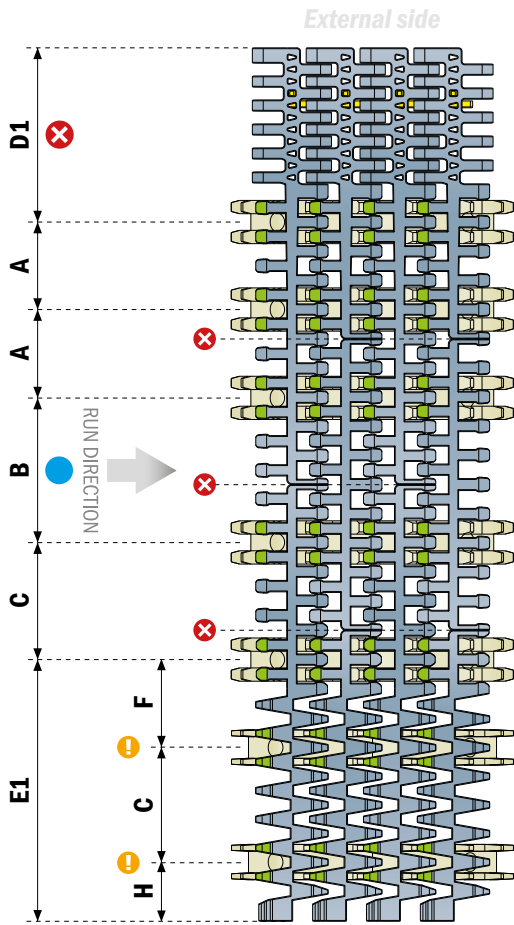
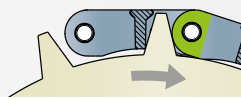

**RIGHT Version**

Belt width (mm)	Recommended n° of sprockets*
340	5
425	6
510	7
595	8
680	9
765	10
850	11

\* Configuration valid for drive and idler section.

If more sprockets are required contact application engineering.

**2 Return section**

Contact point

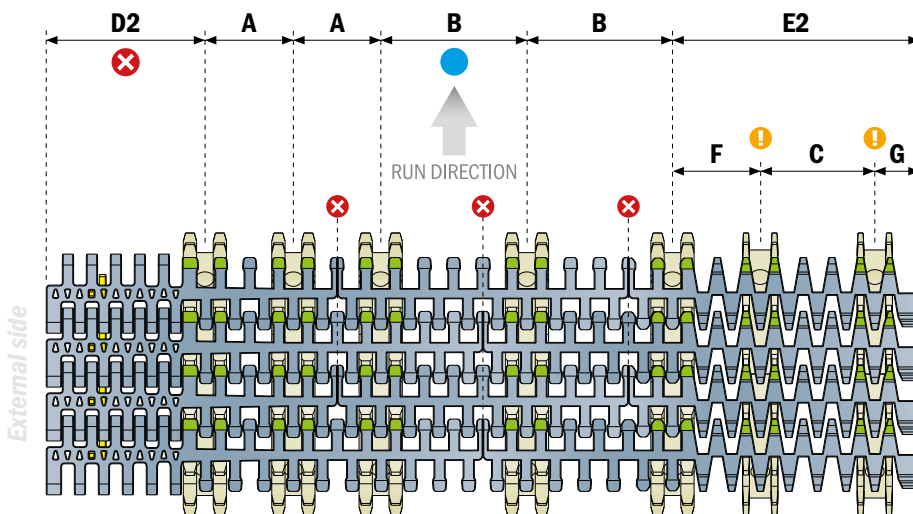
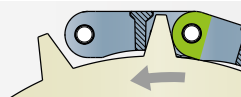

**IMPORTANT**  
Sprockets teeth must press against the hinge loops, never against the module's central bridge in the gap between the hinge loops.

● Add sprocket positions every 85 mm according to 85 mm width increments of the belt corresponding with 85 mm conveyor track pitch system.

✗ It's **NOT** possible to place the sprockets in this position.

! **Small radius section support options:**



**Support sprocket**  
info and order code  
Pag 48



**Split support roller**  
info and order code  
Pag 48

A: 51 mm	B: 85 mm	C: 68 mm	D1: 102 mm	D2: 93.5 mm
E1: 153 mm	E2: 144.5 mm	F: 50.5 mm	G: 26 mm	H: 34.5 mm

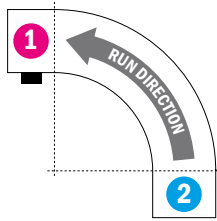

**LEFT  
Version**

Belt width (mm)	Recommended n° of sprockets*
340	5
425	6
510	7
595	8
680	9
765	10
850	11

\* Configuration valid for drive and idler section.

If more sprockets are required contact application engineering.

### IMPORTANT

Sprockets teeth must press against the hinge loops, never against the module's central bridge in the gap between the hinge loops.

● Add sprocket positions every 85 mm according to 85 mm width increments of the belt corresponding with 85 mm conveyor track pitch system.

⊗ It's **NOT** possible to place the sprockets in this position.

#### ! Small radius section support options:



**Support sprocket**  
info and order code  
Pag 48



**Split support roller**  
info and order code  
Pag 48

### 1 Gearmotor section

Contact point

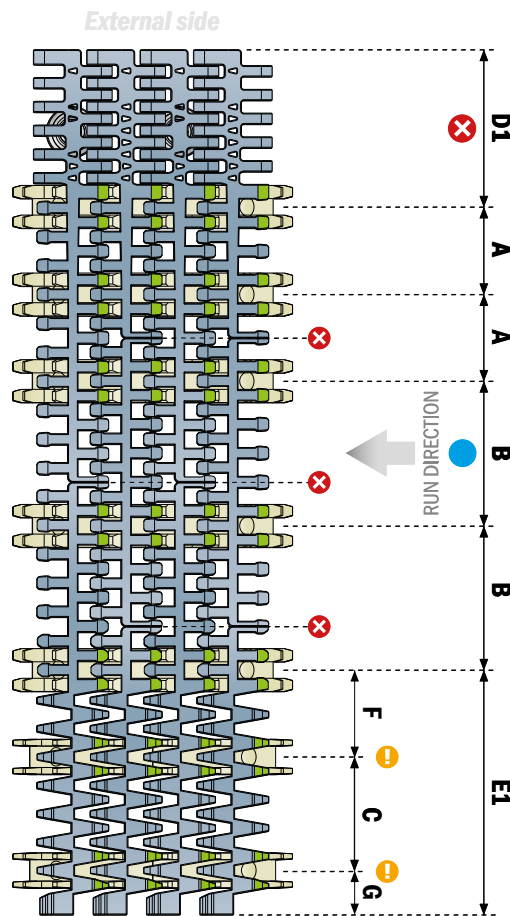
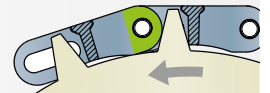

### 2 Return section

Contact point

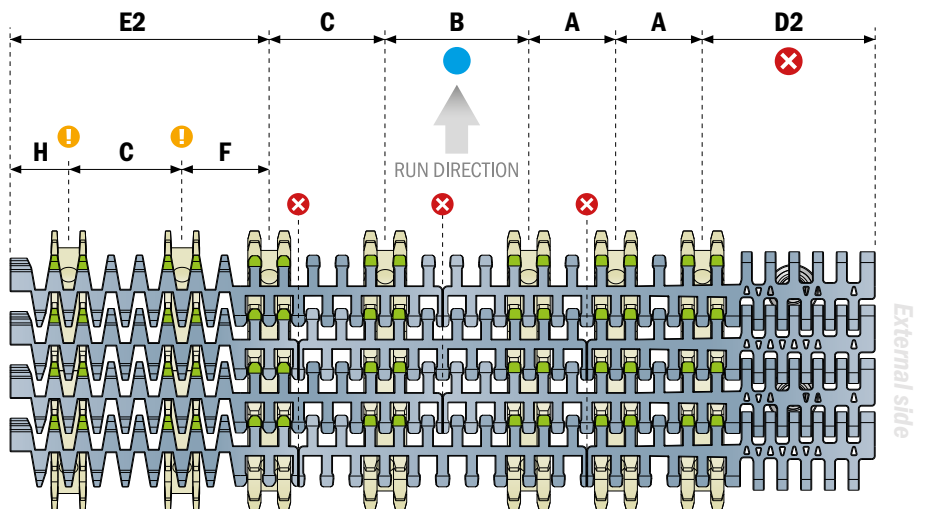
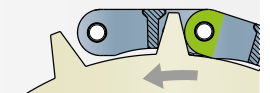

<b>A:</b> 51 mm	<b>B:</b> 85 mm	<b>C:</b> 68 mm	<b>D1:</b> 93.5 mm	<b>D2:</b> 102 mm
<b>E1:</b> 144.5 mm	<b>E2:</b> 153 mm	<b>F:</b> 50.5 mm	<b>G:</b> 26 mm	<b>H:</b> 34.5 mm

### 1 Gearmotor section

Contact point

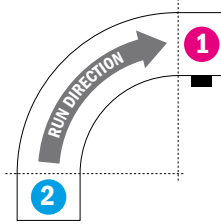
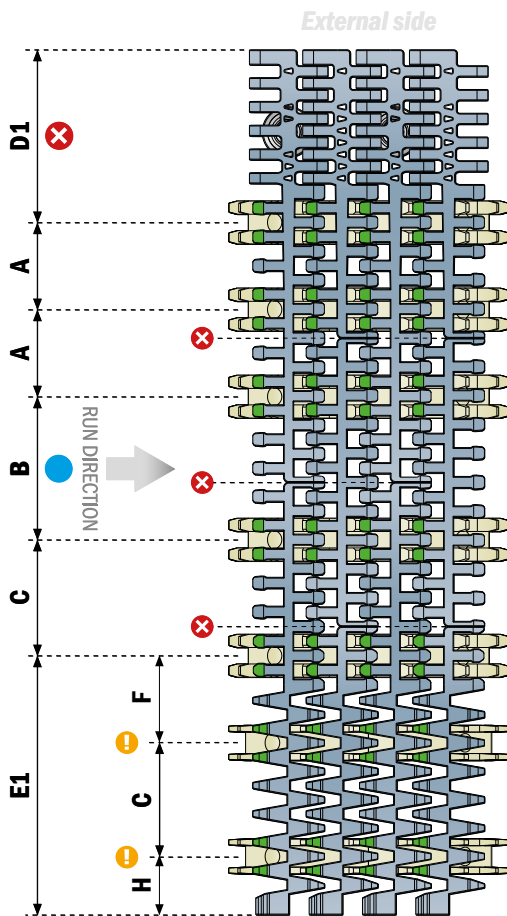
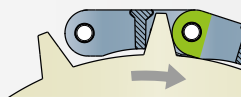

**RIGHT  
Version**

Belt width (mm)	Recommended n° of sprockets*
340	5
425	6
510	7
595	8
680	9
765	10
850	11

\* Configuration valid for drive and idler section.

If more sprockets are required contact application engineering.

### 2 Return section

Contact point

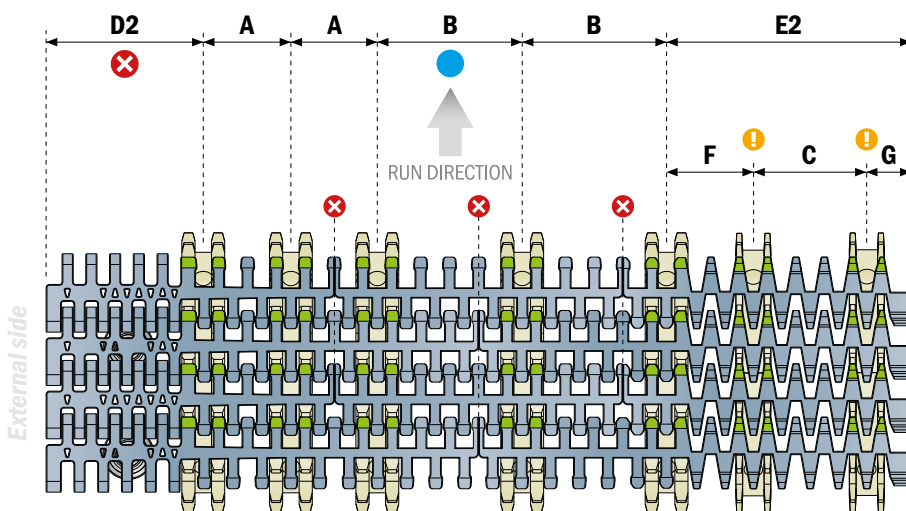
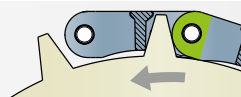

### IMPORTANT

Sprockets teeth must press against the hinge loops, never against the module's central bridge in the gap between the hinge loops.

● Add sprocket positions every 85 mm according to 85 mm width increments of the belt corresponding with 85 mm conveyor track pitch system.

✗ It's **NOT** possible to place the sprockets in this position.

! **Small radius section support options:**



**Support sprocket**  
info and order code  
Pag 48



**Split support roller**  
info and order code  
Pag 48

A: 51 mm	B: 85 mm	C: 68 mm	D1: 102 mm	D2: 93.5 mm
E1: 153 mm	E2: 144.5 mm	F: 50.5 mm	G: 26 mm	H: 34.5 mm

### Support sprockets split drive sprocket, machined

⚙️ **Material:** Polyamide / **Screws:** Stainless steel / **Nuts:** Zinc plated steel

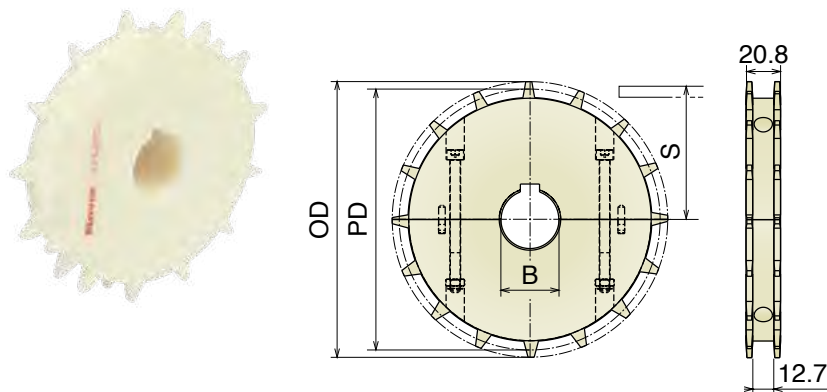

Article-Nr.	Z-	Bore	PD	OD	S
157101SR	10	25	102,8	107,7	45,0
157102SR		30			
157103SR		35			
157104SR		40			
157201SR	13	25	132,7	138,8	60,0
157202SR		30			
157203SR		35			
157204SR		40			
157301SR	15	25	152,7	159,4	70,0
157302SR		30			
157303SR		35			
157304SR		40			
157401SR	16	25	162,8	169,6	75,0
157402SR		30			
157403SR		35			
157404SR		40			

### Support sprockets split idler sprocket, machined

⚙️ **Material:** Polyamide / **Screws:** Stainless steel / **Nuts:** Zinc plated steel

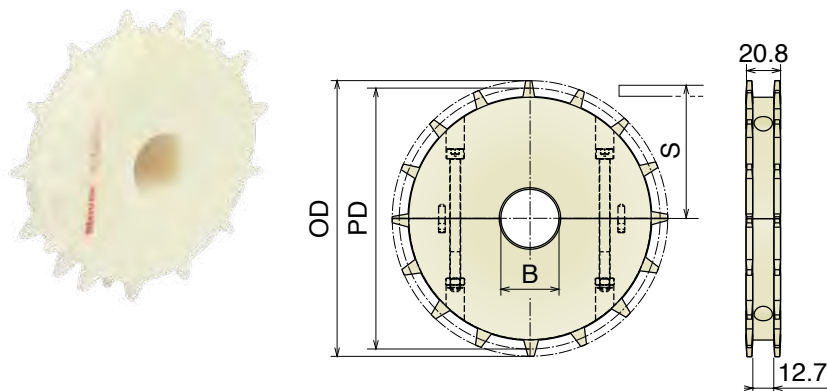

Article-Nr.	Z-	Bore	PD	OD	S
157150SR	10	18*	102,8	107,7	45,0
157151SR		25			
157152SR		30			
157153SR		35			
157154SR		40			
157250SR	13	18*	132,7	138,8	60,0
157251SR		25			
157252SR		30			
157253SR		35			
157254SR		40			
157350SR	15	18*	152,7	159,4	70,0
157351SR		25			
157352SR		30			
157353SR		35			
157354SR		40			
157450SR	16	18*	162,8	169,6	75,0
157451SR		25			
157452SR		30			
157453SR		35			
157454SR		40			

\*Plain Bore

### Split support roller split drive sprocket, machined

⚙️ **Material:** Polyamide / **Screws:** Stainless steel / **Nuts:** Zinc plated steel

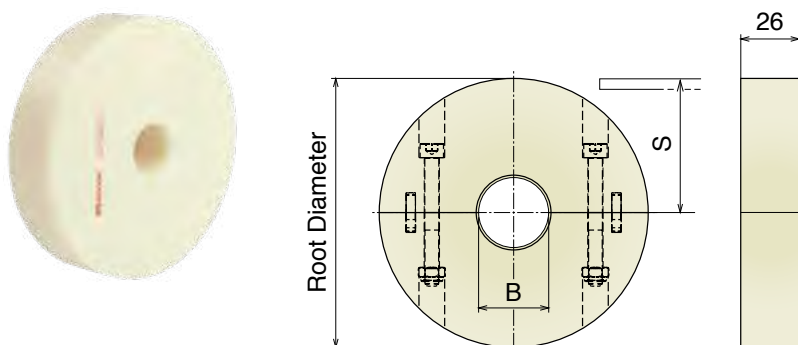

Article-Nr.	Z- eq.	Bore	Root Ø	S
157150R	10	18*	85,1	45,0
157151R		25		
157152R		30		
157153R		35		
157154R		40		
157250R	13	18*	115,0	60,0
157251R		25		
157252R		30		
157253R		35		
157254R		40		
157350R	15	18*	134,3	70,0
157351R		25		
157352R		30		
157353R		35		
157354R		40		
157450R	16	18*	146,8	75,0
157451R		25		
157452R		30		
157453R		35		
157454R		40		



**TECHNICAL RECOMMENDATION:**  
 Fix Split support roller with split collars Part 215  
 Check our general catalogue.



## 2.1 Sprockets position | 500 RR

Belt width (in/mm)	Recommended n° of sprockets*
3 / 76.2	1
6 / 152.4	2
9 / 228.6	3
12 / 304.5	4
15 / 381.0	5
18 / 457.2	6
21 / 533.4	7
24 / 609.6	8
27 / 685.8	9
30 / 762.0	10
33 / 838.2	11
36 / 914.4	12

\*If more sprockets are required contact application engineering.

### IMPORTANT

● Add sprocket positions every 76,2 mm according to 76,2 mm width increments of the belt corresponding with 76,2 mm conveyor track pitch system.

⊗ It's **NOT** possible to place the sprockets in this position.

SPROCKETS POSITION FOR:  
**500 RR**

👁️ BOTTOM VIEW  
● Contact point

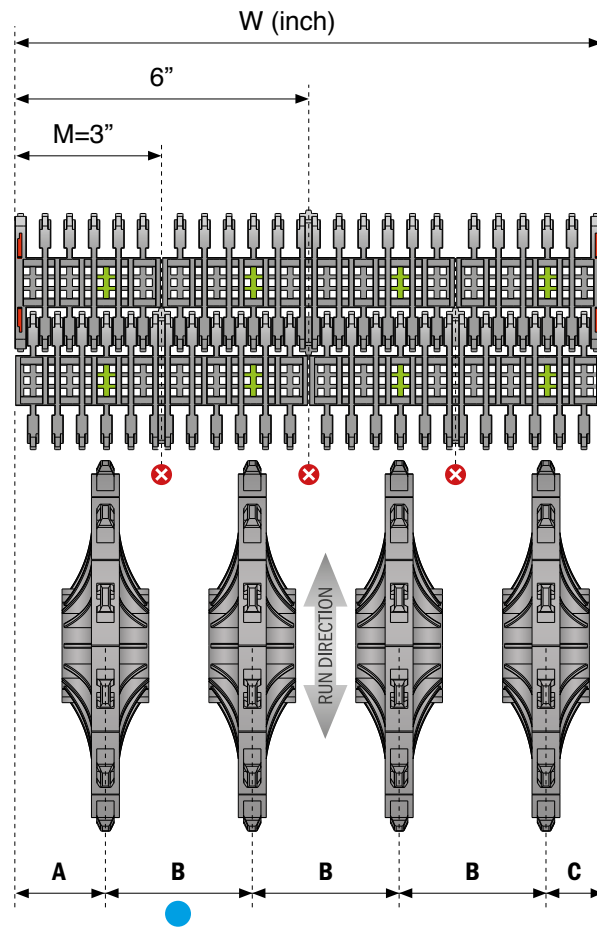

**A: 1,85" (47 mm)    B: 3" (76,2 mm)    C: 1,15" (29,2 mm)**

## Zero contact - Sprockets

Drive sprocket, machined

⚙️ Material: Polyamide



Radius	Article-Nr.	Z-	Bore	Pitch Diam.	Ext. Diam.	S
650	162401	12	40	58,0	61,0	25,6
750	162402			66,0	69,0	29,9
850	162403			76,0	79,0	34,2
950	162404			84,0	86,0	38,5
1050	162405			94,0	97,0	42,8
1150	162406			102,0	104,0	47,1
1250	162407			112,0	114,0	51,4
1350	162408			119,0	122,0	55,7
1450	162409			130,0	132,0	60,0
1550	162410			137,0	140,0	64,3
1650	162411			145,0	148,0	68,6
1750	162412			144,0	157,0	72,9
1850	162413			163,0	166,0	77,2
1950	162414			171,0	174,0	81,5
2050	162415			180,0	183,0	85,8
2150	162416			189,0	192,0	90,1

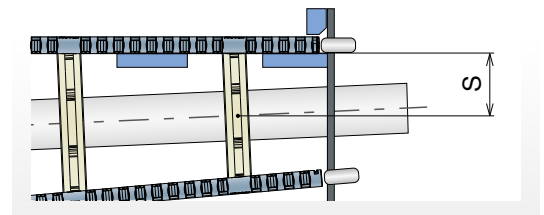

Radius match with the molded number underneath the belt.  
Consult our Engineering department for details.

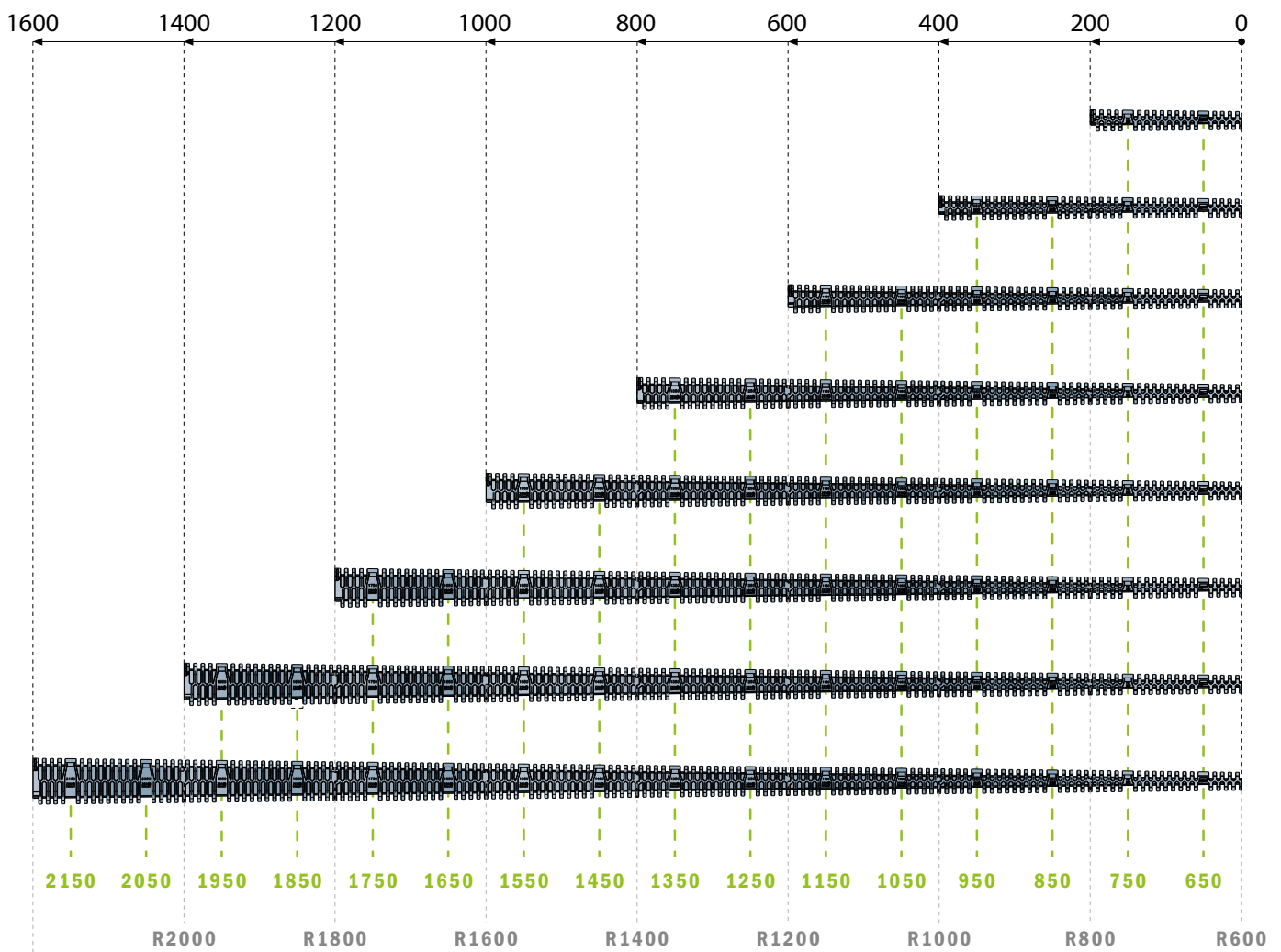

## 2.1 Sprockets position | Zero contact Pro - Sprockets

### Zero contact Pro - Sprockets

#### Drive sprocket, machined

⚙️ **Material:** Polyamide / Screws: Stainless steel  
Nuts: Zinc plated steel



Ref. n°	Article-Nr.	Z-	Bore	R	Pitch Diam.	Ext. Diam.	S
1	163301	13	30	641,1	45,6	45,9	20,3
2	163302			726,9	51,7	52,0	23,3
3	163303		40	812,6	57,8	58,0	26,4
4	163304			897,7	63,8	64,1	29,4
5	163305			983,3	69,9	70,2	32,5
6	163306			1051,8	74,8	76,2	34,9
7	163307			1136,9	80,9	82,3	37,9
8	163308			1222,5	86,9	88,3	41
9	163309			1307,7	93	94,4	44
10	163310			1393,3	99,1	100,5	47
11	163311			1495,3	106,3	106,6	50,7
12	163312			1580,5	114	112,6	53,7
13	163313			1666,1	118,5	118,7	56,8
14	163314			1751,2	124,5	124,7	59,8
15	163315			1837	130,6	130,8	62,8
16	163316			1922,1	136,7	136,9	65,8
17	163317			2007,7	142,8	142,9	68,9

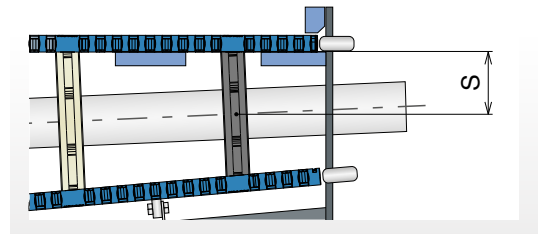
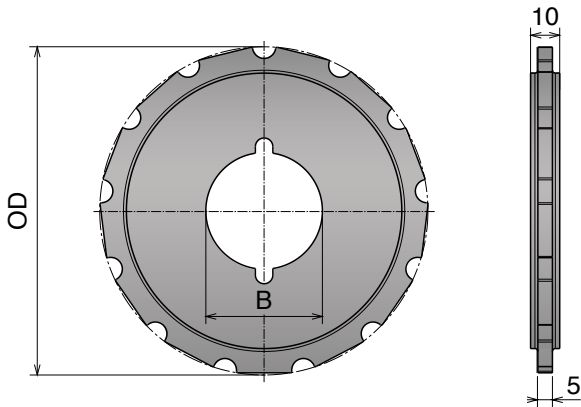

**Radius match with the molded number underneath the belt.**  
Consult our Engineering department for details.

## 2.1 Sprockets position | Zero contact Pro - 1 Track version

LEGEND: Sprockets alignment  | Sprockets reference Number Pag 51

### Width 439

**R586**

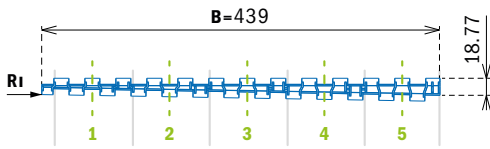

Version	Order code	Track	B Belt width (Tolerance+/-3mm)	Ri Belt radius (Rkurv-14mm)	Number of modules for assembled belt	Weight in Kg (unit)
90°	<b>5461280439A-M</b>	1	439	586	200	8
180°	<b>5461280439B-M</b>	1	439	586	385	15

### Width 524

**R586**

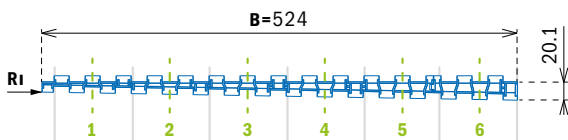

Version	Order code	Track	B Belt width (Tolerance+/-3mm)	Ri Belt radius (Rkurv-14mm)	Number of modules for assembled belt	Weight in Kg (unit)
90°	<b>5461280524A-M</b>	1	524	586	200	9
180°	<b>5461280524B-M</b>	1	524	586	385	17

### Width 864

**R586**

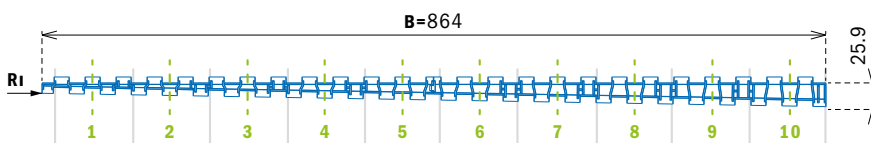

Version	Order code	Track	B Belt width (Tolerance+/-3mm)	Ri Belt radius (Rkurv-14mm)	Number of modules for assembled belt	Weight in Kg (unit)
90°	<b>5461280864A-M</b>	1	864	586	200	16
180°	<b>5461280864B-M</b>	1	864	586	385	30

### Width 1034

**R586**

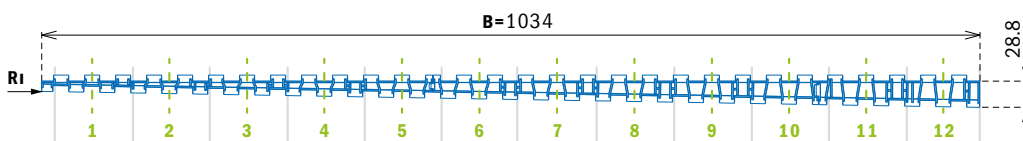

Version	Order code	Track	B Belt width (Tolerance+/-3mm)	Ri Belt radius (Rkurv-14mm)	Number of modules for assembled belt	Weight in Kg (unit)
90°	<b>5461281034A-M</b>	1	1034	586	200	18
180°	<b>5461281034B-M</b>	1	1034	586	385	34

## 2.1 Sprockets position | Zero contact Pro - 1 Track version

LEGEND: Sprockets alignment  | Sprockets reference Number Pag 51

### Width 269

**R756**

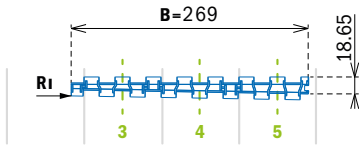

Version	Order code	Track	B <sub>i</sub> Belt width (Tolerance+/-3mm)	R <sub>i</sub> Belt radius (Rkurv-14mm)	Number of modules for assembled belt	Weight in Kg (unit)
90°	<b>5462280269A-M</b>	1	269	756	200	5
180°	<b>5462280269B-M</b>	1	269	756	385	9

### Width 439

**R756**

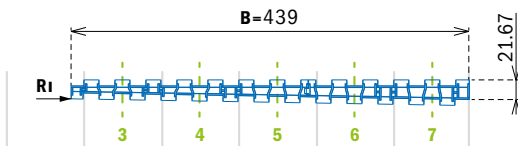

Version	Order code	Track	B <sub>i</sub> Belt width (Tolerance+/-3mm)	R <sub>i</sub> Belt radius (Rkurv-14mm)	Number of modules for assembled belt	Weight in Kg (unit)
90°	<b>5462280439A-M</b>	1	439	756	200	9
180°	<b>5462280439B-M</b>	1	439	756	385	17

### Width 524

**R756**

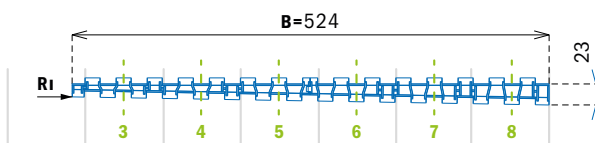

Version	Order code	Track	B Belt width (Tolerance+/-3mm)	R <sub>i</sub> Belt radius (Rkurv-14mm)	Number of modules for assembled belt	Weight in Kg (unit)
90°	<b>5462280524A-M</b>	1	524	756	200	10
180°	<b>5462280524B-M</b>	1	524	756	385	18

### Width 864

**R756**

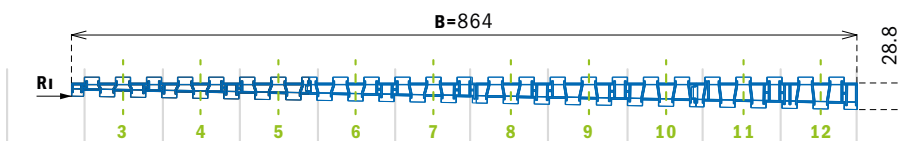

Version	Order code	Track	B Belt width (Tolerance+/-3mm)	R <sub>i</sub> Belt radius (Rkurv-14mm)	Number of modules for assembled belt	Weight in Kg (unit)
90°	<b>5462280864A-M</b>	1	864	756	200	18
180°	<b>5462280864B-M</b>	1	864	756	385	34

## 2.1 Sprockets position | Zero contact Pro - 1 Track version

LEGEND: Sprockets alignment | Sprockets reference Number Pag 51

### Width 1034

**R756**

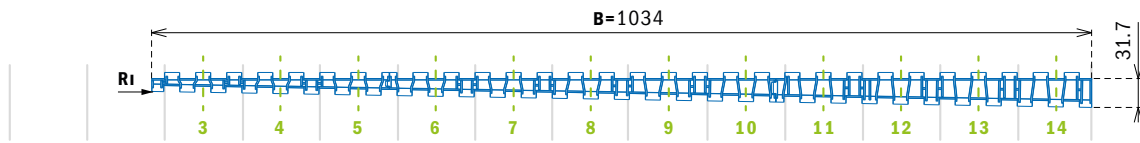

Version	Order code	Track	B Belt width (Tolerance+/-3mm)	Ri Belt radius (Rkurv-14mm)	Number of modules for assembled belt	Weight in Kg (unit)
90°	<b>5462281034A-M</b>	1	1034	756	200	22
180°	<b>5462281034B-M</b>	1	1034	756	385	42

### Width 269

**R1011**

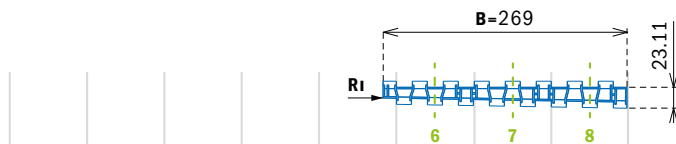

Version	Order code	Track	B Belt width (Tolerance+/-3mm)	Ri Belt radius (Rkurv-14mm)	Number of modules for assembled belt	Weight in Kg (unit)
90°	<b>5463280269A-M</b>	1	269	1011	200	6
180°	<b>5463280269B-M</b>	1	269	1011	385	11

### Width 439

**R1011**

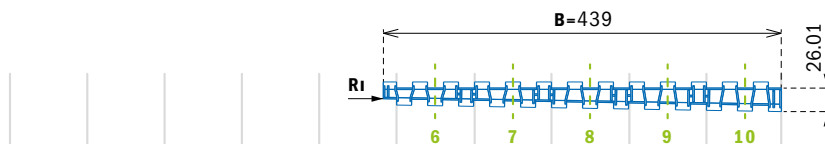

Version	Order code	Track	B Belt width (Tolerance+/-3mm)	Ri Belt radius (Rkurv-14mm)	Number of modules for assembled belt	Weight in Kg (unit)
90°	<b>5463280439A-M</b>	1	439	1011	200	10
180°	<b>5463280439B-M</b>	1	439	1011	385	18

### Width 524

**R1011**

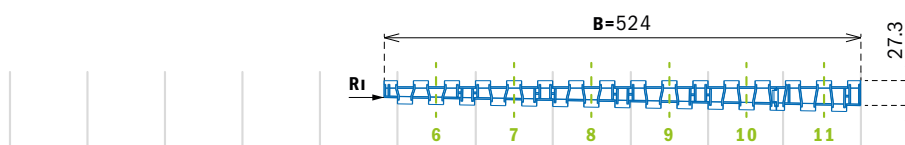

Version	Order code	Track	B Belt width (Tolerance+/-3mm)	Ri Belt radius (Rkurv-14mm)	Number of modules for assembled belt	Weight in Kg (unit)
90°	<b>5463280524A-M</b>	1	524	1011	200	11
180°	<b>5463280524B-M</b>	1	524	1011	385	20

## 2.1 Sprockets position | Zero contact Pro - 1 Track version

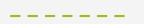
LEGEND: Sprockets alignment  | Sprockets reference Number Pag 51

### Width 864

**R1011**

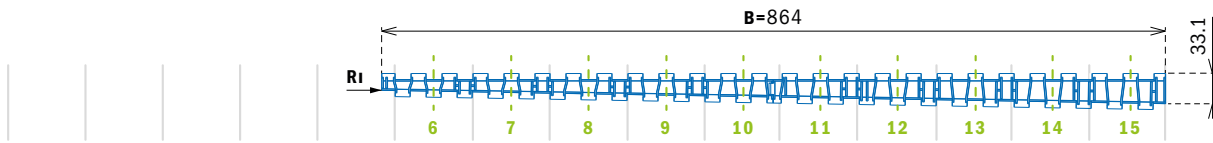

Version	Order code	Track	B Belt width (Tolerance+/-3mm)	Ri Belt radius (Rkurv-14mm)	Number of modules for assembled belt	Weight in Kg (unit)
90°	5463280864A-M	1	864	1011	200	20
180°	5463280864B-M	1	864	1011	385	38

### Width 1034

**R1011**

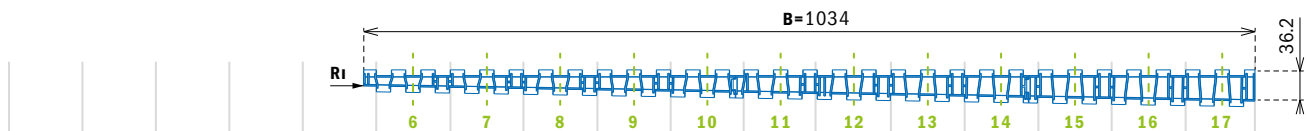

Version	Order code	Track	B Belt width (Tolerance+/-3mm)	Ri Belt radius (Rkurv-14mm)	Number of modules for assembled belt	Weight in Kg (unit)
90°	5463281034A-M	1	1034	1011	200	24
180°	5463281034B-M	1	1034	1011	385	46

### Width 249

**R1031**

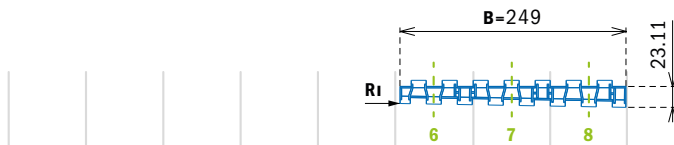

Version	Order code	Track	B Belt width (Tolerance+/-3mm)	Ri Belt radius (Rkurv-14mm)	Number of modules for assembled belt	Weight in Kg (unit)
90°	5465280249A-M	1	249	1031	200	6
180°	5465280249B-M	1	249	1031	385	11

### Width 419

**R1031**

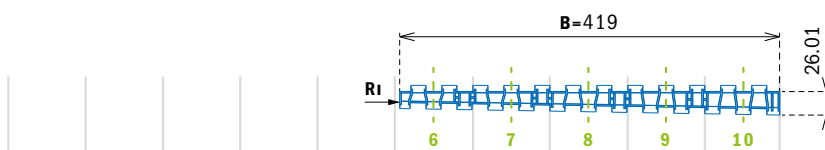

Version	Order code	Track	B Belt width (Tolerance+/-3mm)	Ri Belt radius (Rkurv-14mm)	Number of modules for assembled belt	Weight in Kg (unit)
90°	5464280419A-M	1	419	1031	200	10
180°	5464280419B-M	1	419	1031	385	18

## 2.1 Sprockets position | Zero contact Pro - 1 Track version

LEGEND: Sprockets alignment  | Sprockets reference Number Pag 51

### Width 504

**R1116**

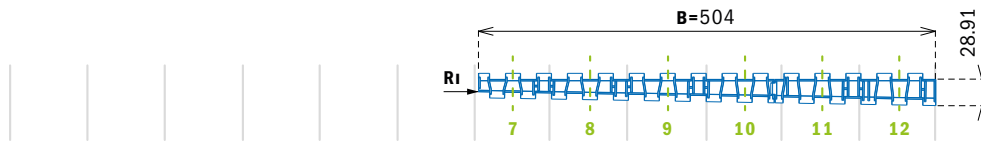

Version	Order code	Track	B Belt width (Tolerance+/-3mm)	Ri Belt radius (Rkurv-14mm)	Number of modules for assembled belt	Weight in Kg (unit)
90°	<b>5464280504A-M</b>	1	504	1116	200	10
180°	<b>5464280504B-M</b>	1	504	1116	385	19

### Width 419

**R1201**

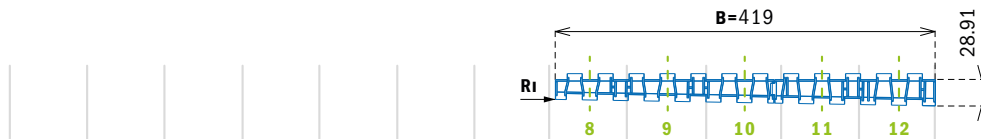

Version	Order code	Track	B Belt width (Tolerance+/-3mm)	Ri Belt radius (Rkurv-14mm)	Number of modules for assembled belt	Weight in Kg (unit)
90°	<b>5465280419A-M</b>	1	419	1201	200	12
180°	<b>5465280419B-M</b>	1	419	1201	385	22

### Width 249

**R1286**



Version	Order code	Track	B Belt width (Tolerance+/-3mm)	Ri Belt radius (Rkurv-14mm)	Number of modules for assembled belt	Weight in Kg (unit)
90°	<b>5466280249A-M</b>	1	249	1286	200	8
180°	<b>5466280249B-M</b>	1	249	1286	385	15

### Width 504

**R1286**

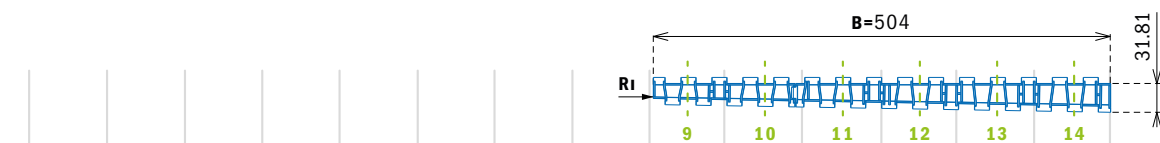

Version	Order code	Track	B Belt width (Tolerance+/-3mm)	Ri Belt radius (Rkurv-14mm)	Number of modules for assembled belt	Weight in Kg (unit)
90°	<b>5465280504A-M</b>	1	504	1286	200	13
180°	<b>5465280504B-M</b>	1	504	1286	385	24



## 2.1 Sprockets position | Zero contact Pro - 1 Track version

LEGEND: Sprockets alignment - - - - - | Sprockets reference Number Pag 51

### Width 419

**R1456**



Version	Order code	Track	B Belt width (Tolerance+/-3mm)	Ri Belt radius (Rkurv-14mm)	Number of modules for assembled belt	Weight in Kg (unit)
90°	<b>5466280419A-M</b>	1	419	1456	200	14
180°	<b>5466280419B-M</b>	1	419	1456	385	26

### Width 504

**R1541**



Version	Order code	Track	B Belt width (Tolerance+/-3mm)	Ri Belt radius (Rkurv-14mm)	Number of modules for assembled belt	Weight in Kg (unit)
90°	<b>5466280504A-M</b>	1	504	1541	200	17
180°	<b>5466280504A-M</b>	1	504	1541	385	31

## 2.1 Sprockets position | Zero contact Pro - 1 Track version with Bearings

LEGEND: Sprockets alignment  |  Bearing | Sprockets reference Number Pag 51

### Width 249

**R1031**

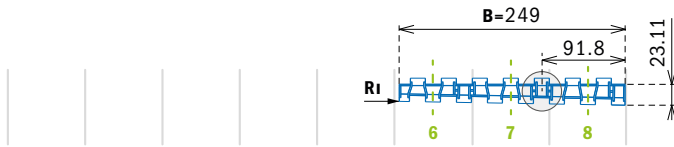

Version	Order code	Track	B <sub>0</sub> Belt width (Tolerance+/-3mm)	R <sub>0</sub> Belt radius (=R <sub>i</sub> +B <sub>i</sub> +6mm)	Number of modules for assembled belt	Weight in Kg (unit)
90°	<b>5462280249A-M</b>	1	249	1031	200	6
180°	<b>5462280249B-M</b>	1	249	1031	385	11

### Width 419

**R1031**

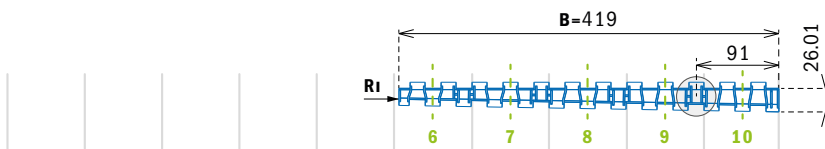

Version	Order code	Track	B <sub>0</sub> Belt width (Tolerance+/-3mm)	R <sub>0</sub> Belt radius (=R <sub>i</sub> +B <sub>i</sub> +6mm)	Number of modules for assembled belt	Weight in Kg (unit)
90°	<b>5461280419A-M</b>	1	419	1031	200	9
180°	<b>5461280419B-M</b>	1	419	1031	385	17

### Width 504

**R1116**

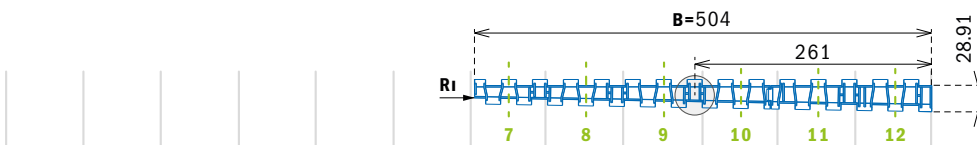

Version	Order code	Track	B <sub>0</sub> Belt width (Tolerance+/-3mm)	R <sub>0</sub> Belt radius (=R <sub>i</sub> +B <sub>i</sub> +6mm)	Number of modules for assembled belt	Weight in Kg (unit)
90°	<b>5461280504A-M</b>	1	504	1116	200	10
180°	<b>5461280504B-M</b>	1	504	1116	385	18

### Width 419

**R1201**

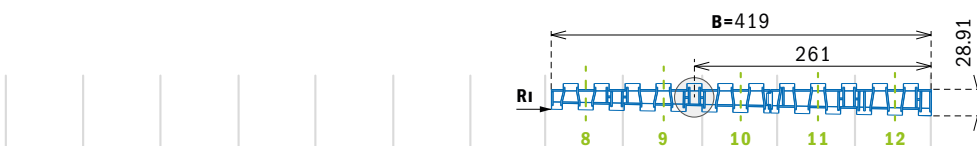

Version	Order code	Track	B <sub>0</sub> Belt width (Tolerance+/-3mm)	R <sub>0</sub> Belt radius (=R <sub>i</sub> +B <sub>i</sub> +6mm)	Number of modules for assembled belt	Weight in Kg (unit)
90°	<b>5462280419A-M</b>	1	419	1201	200	10
180°	<b>5462280419B-M</b>	1	419	1201	385	18

## 2.1 Sprockets position | Zero contact Pro - 1 Track version with Bearings

LEGEND: Sprockets alignment  |  Bearing | Sprockets reference Number Pag 51

### Width 249

**R1286**

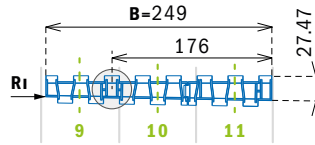

Version	Order code	Track	B <sub>0</sub> Belt width (Tolerance+/-3mm)	R <sub>0</sub> Belt radius (=R <sub>i</sub> +B <sub>i</sub> +6mm)	Number of modules for assembled belt	Weight in Kg (unit)
90°	<b>5463280249A-M</b>	1	249	1286	200	7
180°	<b>5463280249B-M</b>	1	249	1286	385	13

### Width 504

**R1286**

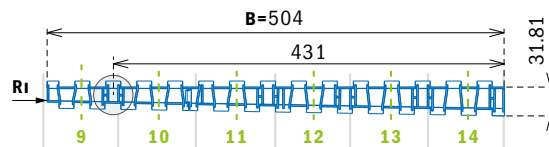

Version	Order code	Track	B <sub>0</sub> Belt width (Tolerance+/-3mm)	R <sub>0</sub> Belt radius (=R <sub>i</sub> +B <sub>i</sub> +6mm)	Number of modules for assembled belt	Weight in Kg (unit)
90°	<b>5462280504A-M</b>	1	504	1286	200	11
180°	<b>5462280504B-M</b>	1	504	1286	385	20

### Width 419

**R1456**

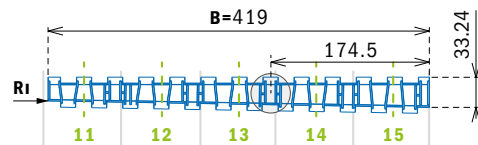

Version	Order code	Track	B <sub>0</sub> Belt width (Tolerance+/-3mm)	R <sub>0</sub> Belt radius (=R <sub>i</sub> +B <sub>i</sub> +6mm)	Number of modules for assembled belt	Weight in Kg (unit)
90°	<b>5463280419A-M</b>	1	419	1456	200	11
180°	<b>5463280419B-M</b>	1	419	1456	385	20

### Width 504

**R1541**

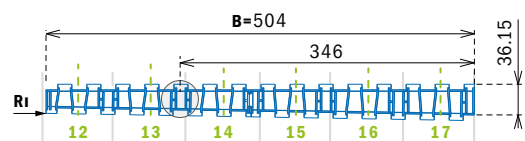

Version	Order code	Track	B <sub>0</sub> Belt width (Tolerance+/-3mm)	R <sub>0</sub> Belt radius (=R <sub>i</sub> +B <sub>i</sub> +6mm)	Number of modules for assembled belt	Weight in Kg (unit)
90°	<b>5463280504A-M</b>	1	504	1541	200	12
180°	<b>5463280504B-M</b>	1	504	1541	385	22

## 2.1 Sprockets position | Zero contact Pro - 2 Track version

LEGEND: Sprockets alignment  |  Bearing | Sprockets reference Number Pag 51

### Width 864 (439/419)

**R586**

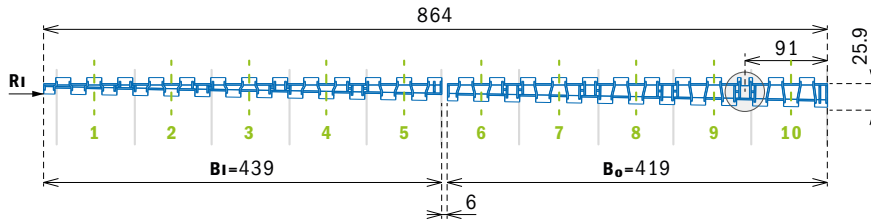

inner belt - without bearing - on bottom side

Version	Order code	Track	$B_i$ Belt width (Tolerance+/-3mm)	$R_i$ Belt radius (Rkurv-14mm)	Number of modules for assembled belt	Weight in Kg (unit)
90°	<b>5461280439A-M</b>	1	439	586	200	8
180°	<b>5461280439B-M</b>	1	439	586	385	15

outer belt - with bearing - on bottom side

Version	Order code	Track	$B_o$ Belt width (Tolerance+/-3mm)	$R_o$ Belt radius (= $R_i+B_i+6$ mm)	Number of modules for assembled belt	Weight in Kg (unit)
90°	<b>5461280419A-M</b>	1	419	1031	200	9
180°	<b>5461280419B-M</b>	1	419	1031	385	17

### Width 1034 (524/504)

**R586**

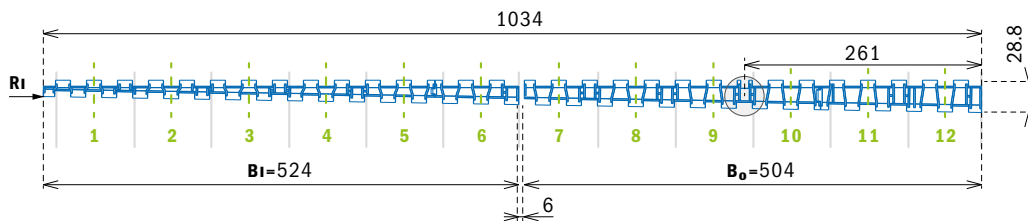

inner belt - without bearing - on bottom side

Version	Order code	Track	$B_i$ Belt width (Tolerance+/-3mm)	$R_i$ Belt radius (Rkurv-14mm)	Number of modules for assembled belt	Weight in Kg (unit)
90°	<b>5461280524A-M</b>	1	524	586	200	9
180°	<b>5461280524B-M</b>	1	524	586	385	17

outer belt - with bearing - on bottom side

Version	Order code	Track	$B_o$ Belt width (Tolerance+/-3mm)	$R_o$ Belt radius (= $R_i+B_i+6$ mm)	Number of modules for assembled belt	Weight in Kg (unit)
90°	<b>5461280504A-M</b>	1	504	1116	200	10
180°	<b>5461280504B-M</b>	1	504	1116	385	18

## 2.1 Sprockets position | Zero contact Pro - 2 Track version

LEGEND: Sprockets alignment  |  Bearing | Sprockets reference Number Pag 51

### Width 524 (269/249)

**R756**

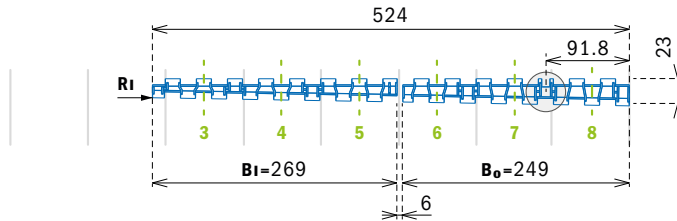

inner belt - without bearing - on bottom side

Version	Order code	Track	$B_i$ Belt width (Tolerance+/-3mm)	$R_i$ Belt radius (Rkurv-14mm)	Number of modules for assembled belt	Weight in Kg (unit)
90°	<b>5462280269A-M</b>	1	269	756	200	5
180°	<b>5462280269B-M</b>	1	269	756	385	9

outer belt - with bearing - on bottom side

Version	Order code	Track	$B_o$ Belt width (Tolerance+/-3mm)	$R_o$ Belt radius (= $R_i+B_i+6$ mm)	Number of modules for assembled belt	Weight in Kg (unit)
90°	<b>5462280249A-M</b>	1	249	1031	200	6
180°	<b>5462280249B-M</b>	1	249	1031	385	11

### Width 864 (439/419)

**R756**

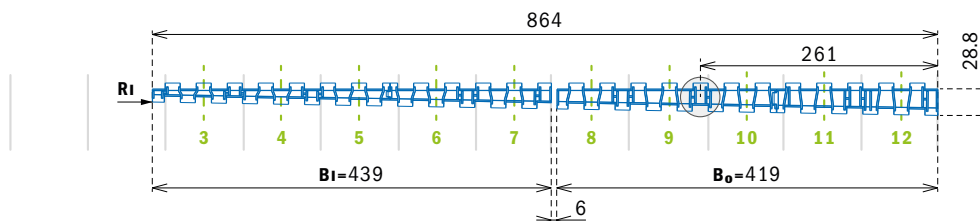

inner belt - without bearing - on bottom side

Version	Order code	Track	$B_i$ Belt width (Tolerance+/-3mm)	$R_i$ Belt radius (Rkurv-14mm)	Number of modules for assembled belt	Weight in Kg (unit)
90°	<b>5462280439A-M</b>	1	439	756	200	9
180°	<b>5462280439B-M</b>	1	439	756	385	17

outer belt - with bearing - on bottom side

Version	Order code	Track	$B_o$ Belt width (Tolerance+/-3mm)	$R_o$ Belt radius (= $R_i+B_i+6$ mm)	Number of modules for assembled belt	Weight in Kg (unit)
90°	<b>5462280419A-M</b>	1	419	1201	200	10
180°	<b>5462280419B-M</b>	1	419	1201	385	18

## 2.1 Sprockets position | Zero contact Pro - 2 Track version

LEGEND: Sprockets alignment  |  Bearing | Sprockets reference Number Pag 51

### Width 1034 (524/504)

**R756**

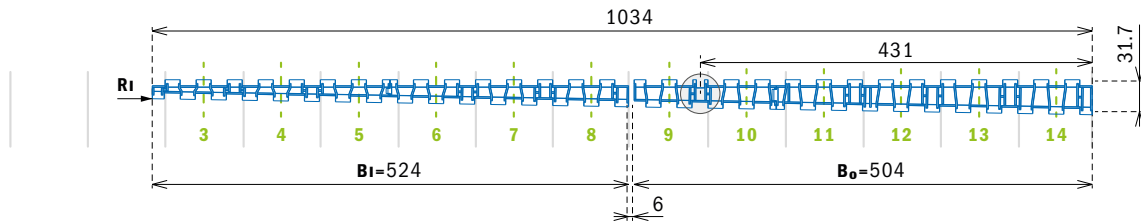

inner belt - without bearing - on bottom side

Version	Order code	Track	B <sub>I</sub> Belt width (Tolerance+/-3mm)	R <sub>I</sub> Belt radius (Rkurv-14mm)	Number of modules for assembled belt	Weight in Kg (unit)
90°	<b>5462280524A-M</b>	1	524	756	200	10
180°	<b>5462280524B-M</b>	1	524	756	385	18

outer belt - with bearing - on bottom side

Version	Order code	Track	B <sub>O</sub> Belt width (Tolerance+/-3mm)	R <sub>O</sub> Belt radius (=R <sub>I</sub> +B <sub>I</sub> +6mm)	Number of modules for assembled belt	Weight in Kg (unit)
90°	<b>5462280504A-M</b>	1	504	1286	200	11
180°	<b>5462280504B-M</b>	1	504	1286	385	20

### Width 524 (269/249)

**R1011**

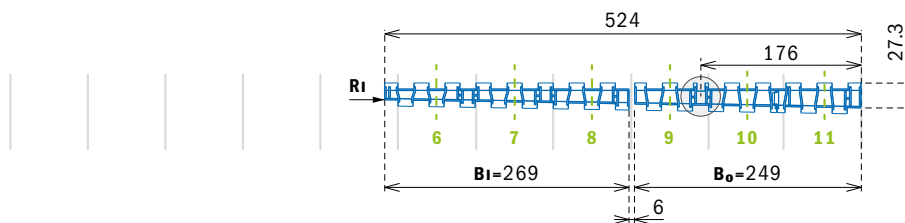

inner belt - without bearing - on bottom side

Version	Order code	Track	B <sub>I</sub> Belt width (Tolerance+/-3mm)	R <sub>I</sub> Belt radius (Rkurv-14mm)	Number of modules for assembled belt	Weight in Kg (unit)
90°	<b>5463280269A-M</b>	1	269	1011	200	6
180°	<b>5463280269B-M</b>	1	269	1011	385	11

outer belt - with bearing - on bottom side

Version	Order code	Track	B <sub>O</sub> Belt width (Tolerance+/-3mm)	R <sub>O</sub> Belt radius (=R <sub>I</sub> +B <sub>I</sub> +6mm)	Number of modules for assembled belt	Weight in Kg (unit)
90°	<b>5463280249A-M</b>	1	249	1286	200	7
180°	<b>5463280249B-M</b>	1	249	1286	385	13

## 2.1 Sprockets position | Zero contact Pro - 2 Track version

LEGEND: Sprockets alignment | Bearing | Sprockets reference Number Pag 51

### Width 864 (439/419)

**R1011**

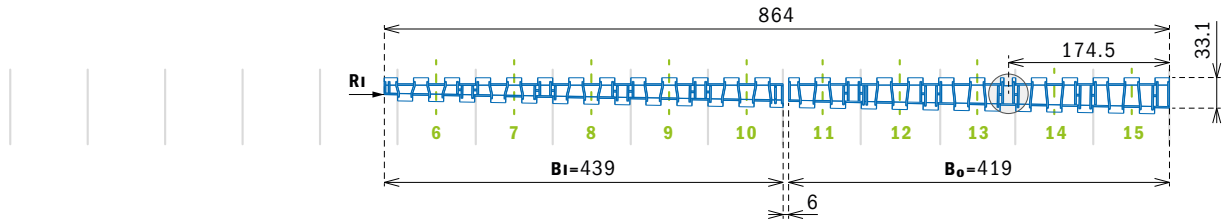

inner belt - without bearing - on bottom side

Version	Order code	Track	$B_i$ Belt width (Tolerance+/-3mm)	$R_i$ Belt radius (Rkurv-14mm)	Number of modules for assembled belt	Weight in Kg (unit)
90°	<b>5463280439A-M</b>	1	439	1011	200	10
180°	<b>5463280439B-M</b>	1	439	1011	385	18

outer belt - with bearing - on bottom side

Version	Order code	Track	$B_o$ Belt width (Tolerance+/-3mm)	$R_o$ Belt radius (=Ri+Bi+6mm)	Number of modules for assembled belt	Weight in Kg (unit)
90°	<b>5463280419A-M</b>	1	419	1456	200	11
180°	<b>5463280419B-M</b>	1	419	1456	385	20

### Width 1034 (524/504)

**R1011**

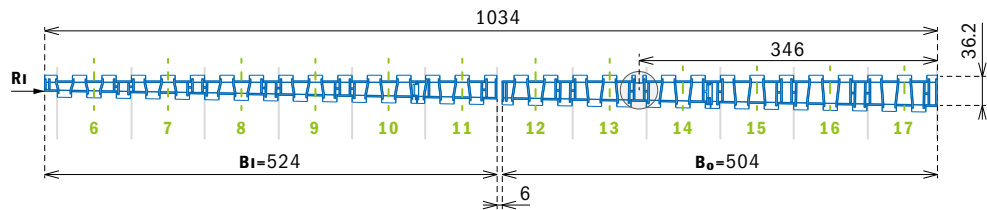

inner belt - without bearing - on bottom side

Version	Order code	Track	$B_i$ Belt width (Tolerance+/-3mm)	$R_i$ Belt radius (Rkurv-14mm)	Number of modules for assembled belt	Weight in Kg (unit)
90°	<b>5463280524A-M</b>	1	524	1011	200	11
180°	<b>5463280524A-M</b>	1	524	1011	385	20

outer belt - with bearing - on bottom side

Version	Order code	Track	$B_o$ Belt width (Tolerance+/-3mm)	$R_o$ Belt radius (=Ri+Bi+6mm)	Number of modules for assembled belt	Weight in Kg (unit)
90°	<b>5463280504A-M</b>	1	504	1541	200	12
180°	<b>5463280504A-M</b>	1	504	1541	385	22

## 2.2 Matching sprockets sizes | S Dimension

In some cases, it's necessary to run different chains/belts side by side. In order to find the closest matching sprockets, the following graphs can be used as a guideline.

### S dimension

Is specified for each sprocket and idler wheel type and size in the catalogue.

It defines the distance between sprocket/idler (=shaft) centre and top of wear strip. It ensures smooth run of the chain at minimum noise level.

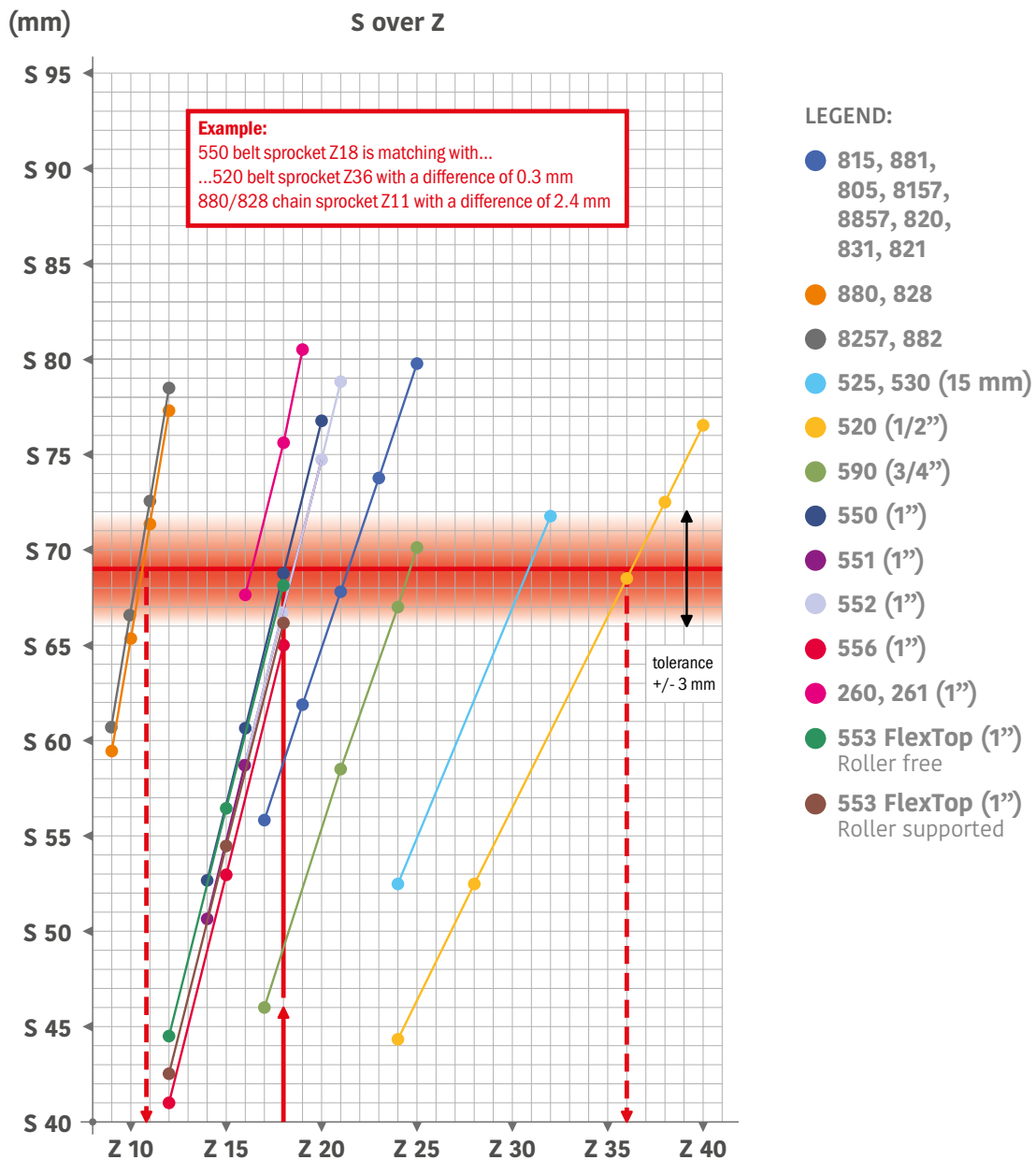
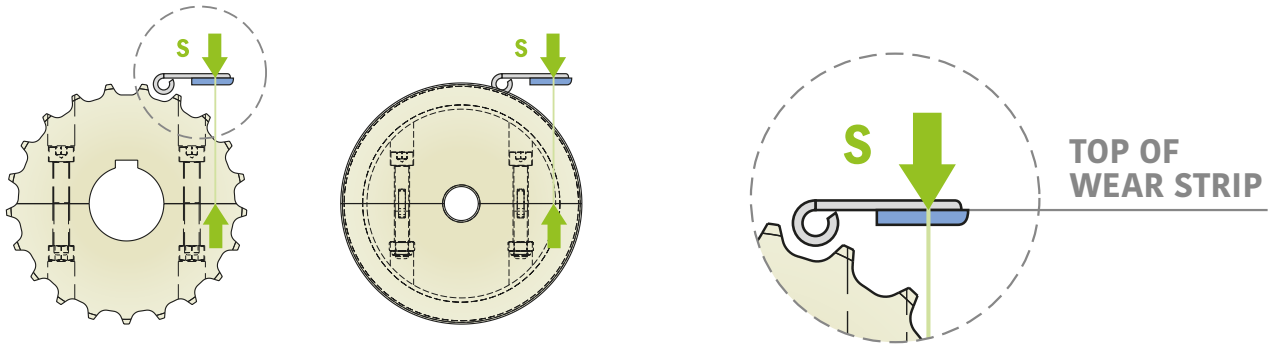



## 2.2 Matching sprockets sizes | TOC Dimension

### TOC dimension

Calculate:  $TOC = S + CBP$  [mm]     $CBP =$  plate thickness of chain/belt

Not specified in the catalogue.

It defines the distance between sprocket/idler (=shaft) centre and top of chain/belt. It helps determining the height level of wear strips in order to achieve matching top levels of different chains or belts running side by side and without or minimizing transfer step.

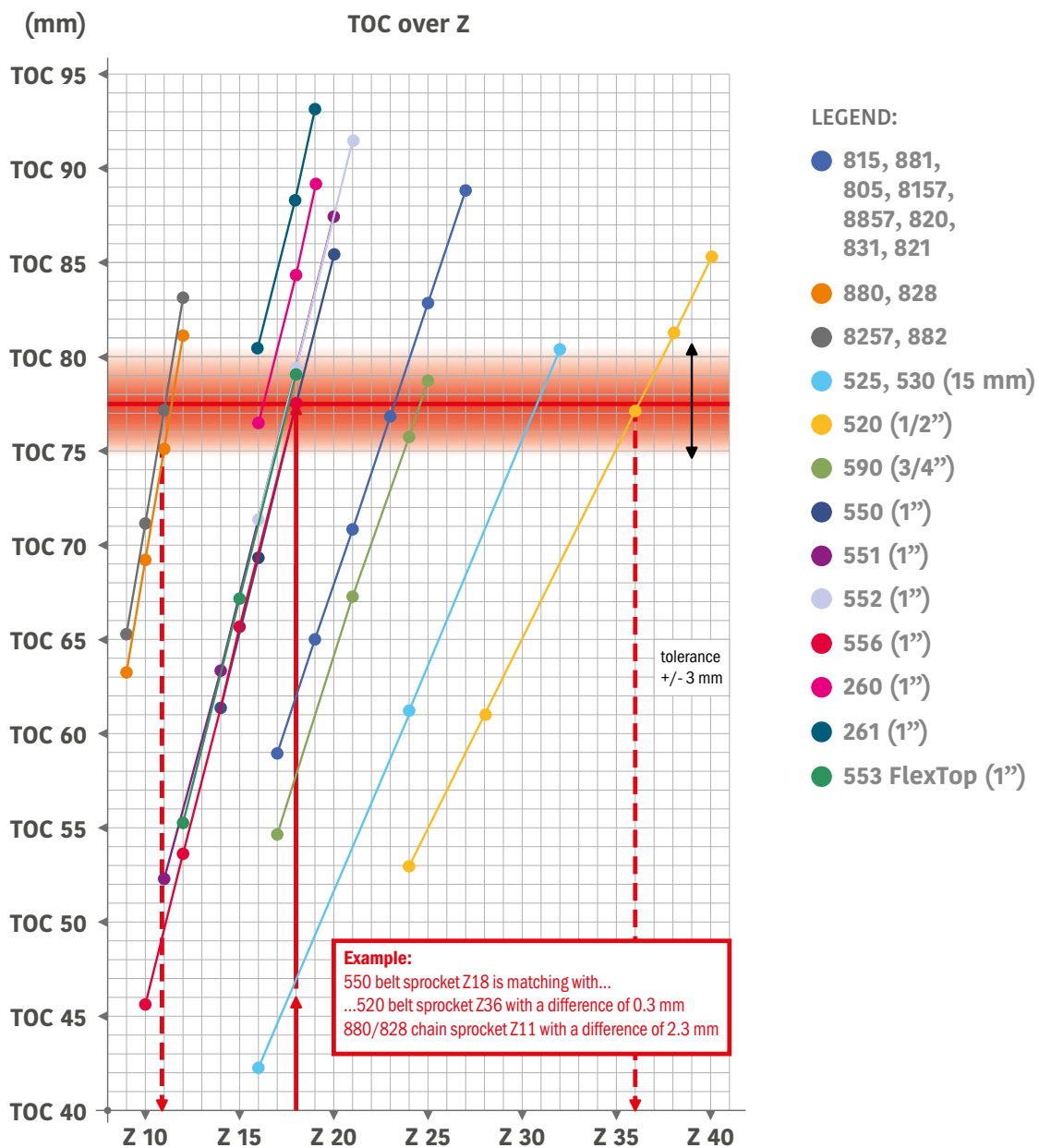
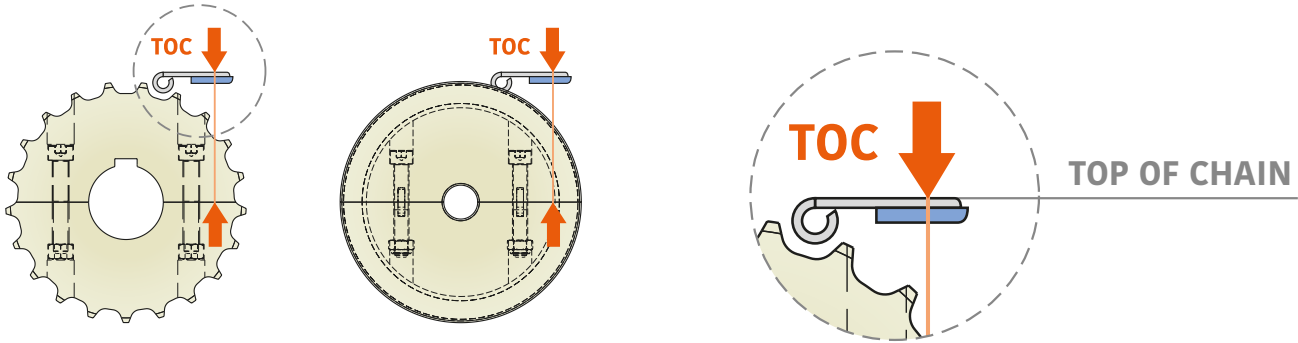

## 2.2 Matching sprockets sizes | S & TOC Dimension

### 815 - 881 - 805 - 8157 - 8857

#### 820 - 831 - 821 Series

Plate thickness 3,1 mm

Z-Teeth N°	Pitch Ø [mm]	S-dim. [mm]	TOC-dim. [mm]
17	105,5	55,9	59
19	117,3	61,9	65
21	129,3	67,8	70,9
23	141,2	73,8	76,9
25	153,2	79,8	82,9
27	165,2	85,8	88,9
29	177,2	91,8	94,9

### 880 - 828 Series

Plate thickness 4 mm

Z-Teeth N°	Pitch Ø [mm]	S-dim. [mm]	TOC-dim. [mm]
9	111,4	59,3	63,3
10	123,3	65,25	69,25
11	135,2	71,2	75,2
12	147,2	77,2	81,2

### 8257 - 882 Series

Plate thickness 4,8 mm

Z-Teeth N°	Pitch Ø [mm]	S-dim. [mm]	TOC-dim. [mm]
9	111,4	60,5	65,3
10	123,2	66,4	71,2
11	135,2	72,4	78,4
12	147,2	78,4	83,2

### 520- 522 Series (1/2")

Plate thickness 8,7 mm

Z-Teeth N°	Pitch Ø [mm]	S-dim. [mm]	TOC-dim. [mm]
24	97,3	44,3	53
28	113,4	52,4	61,1
36	145,7	68,5	77,2
38	153,8	72,6	81,3
40	161,9	76,6	85,3

### 525 - 530 Series (15 mm)

Plate thickness 8,7 mm

Z-Teeth N°	Pitch Ø [mm]	S-dim. [mm]	TOC-dim. [mm]
12	58,1	24,1	32,8
16	77,1	33,6	42,3
24	114,9	52,5	61,2
32	153,4	71,75	80,45

### 590 Series (3/4")

Plate thickness 8,7 mm

Z-Teeth N°	Pitch Ø [mm]	S-dim. [mm]	TOC-dim. [mm]
17	100,7	46	54,7
21	126	58,65	67,35
24	142,9	67,1	75,8
25	149	70,15	78,85

### 550 Series (1")

Plate thickness 8,7 mm

Z-Teeth N°	Pitch Ø [mm]	S-dim. [mm]	TOC-dim. [mm]
14	114,1	52,7	61,4
16	130,2	60,7	69,4
18	146,3	68,8	77,5
20	162,4	76,8	85,5

### 551 Series (1")

Plate thickness 12,7 mm

Z-Teeth N°	Pitch Ø [mm]	S-dim. [mm]	TOC-dim. [mm]
11	90,2	39,7	52,4
14	114,2	50,7	63,4
16	130,2	58,7	71,4
18	146,3	66,7	79,4
20	162,4	74,8	87,5

### 552 Series (1")

Plate thickness 12,7 mm

Z-Teeth N°	Pitch Ø [mm]	S-dim. [mm]	TOC-dim. [mm]
16	130,2	58,7	71,4
18	146,3	66,8	79,5
21	170,4	78,8	91,5
24	202,7	95	107,7

### 553 Series (1")

Plate thickness 8,7 mm

Z-Teeth N°	Pitch Ø [mm]	S-dim. [mm]	TOC-dim. [mm]
12	98,1	44,5	53,2
15	122,2	56,5	65,2
18	146,3	68,5	77,2

### 556 Series (1")

Plate thickness 12,7 mm

Z-Teeth N°	Pitch Ø [mm]	S-dim. [mm]	TOC-dim. [mm]
10	82,2	33	45,7
12	98,1	41	53,7
15	122,2	53	65,7
18	146,3	65	77,7

### 260 Series (1")

Plate thickness 8,7 mm

Z-Teeth N°	Pitch Ø [mm]	S-dim. [mm]	TOC-dim. [mm]
16	128,9	67,8	76,5
18	144,8	75,7	84,4
19	154,3	80,5	89,2

### 261 Series (1")

Plate thickness 12,7 mm

Z-Teeth N°	Pitch Ø [mm]	S-dim. [mm]	TOC-dim. [mm]
16	128,9	67,8	80,5
18	144,8	75,7	88,4
19	154,3	80,5	93,2

### 553 FlexTop (1")

Plate thickness 12,7 mm - Roller ø 12,7 mm

Z-Teeth N°	Pitch Ø [mm]	S-dim. [mm]	S-dim. [mm]	TOC-dim. [mm]
12	98,1	44,5	42,5	55,2
15	122,2	56,5	54,5	67,2
18	146,3	68,5	66,5	79,2

Rollers free      Rollers supported

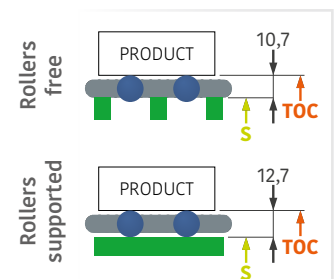

## 2.3 Sprockets and idler bore tolerance

### Sprockets and Keyway

Fixed on the Shaft

Recommended  
tightening torque 12 Nm

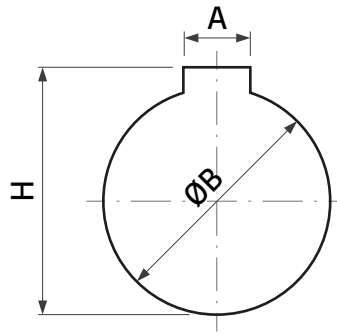

Sprockets						Keyway	
Bore - ØB		Upper		Lower		A	H
Nominal (mm)	Tolerance	DIN ISO 286 (µm)	Absolute (mm)	DIN ISO 286 (µm)	Absolute (mm)	ISO 773 / DIN 6885 (mm)	(mm)
25	P9	-22	24,978	-74	24,926	8	28,3
30	P9	-26	29,974	-88	29,912	8	33,3
35	P9	-26	34,974	-88	34,912	10	38,3
40	P9	-26	39,974	-88	39,912	12	43,3

All sprockets with tight seat tolerance P9 are also available with plus tolerance +0,3 / +0,5, floating on the shaft. Just add an "X" to the article number.

### Idlers

Floating on the Shaft

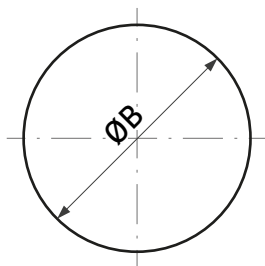

### Sprockets with square bore

Floating on the Shaft

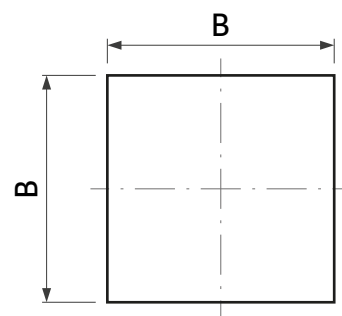

Bore - ØB	Upper		Lower	
	(mm)	Absolute (mm)	(mm)	Absolute (mm)
25	0,4	25,4	0,3	25,3
30	0,4	30,4	0,3	30,3
35	0,4	35,4	0,3	35,3
40	0,4	40,4	0,3	40,3

Bore - √B	Upper		Lower	
	(mm)	Absolute (mm)	(mm)	Absolute (mm)
25	0,4	25,4	0,3	25,3
30	0,4	30,4	0,3	30,3
35	0,4	35,4	0,3	35,3
40	0,4	40,4	0,3	40,3

## 2.4 Fixed and floating sprockets/idlers on the shaft

Sprockets/idlers with plus bore tolerance, floating on the shaft version, can be fixed regarding their axial position on the shaft, by means of shaft collars.



e.g. Part. 221



e.g. Part. 215



e.g. Part. 217

	Fixed	Floating
Chains, straight running and side-flexing.	Yes.	
Single track belts, "chainbelts", straight running and side-flexing.	Yes, same principle as chains.	
Multi-track modular belts, straight running.	Yes, only the sprocket in the same position as positioners [1].	Yes, if the belt is not guided by means of positioners.
Multi-track modular belts, side-flexing.	Yes, only the exterior sprocket, if the belt is guided at the exterior track.	Yes, if the belt is guided inside [2] [3].
Zero contact curve belts.	Yes.	

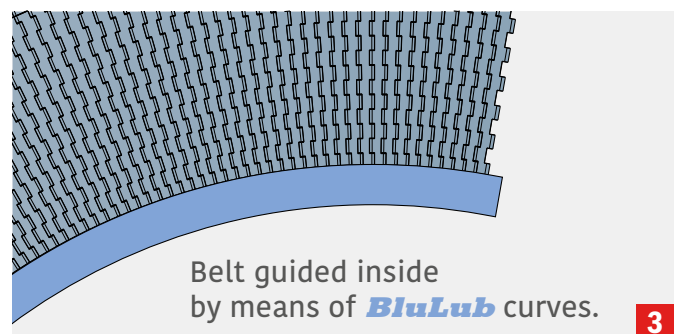
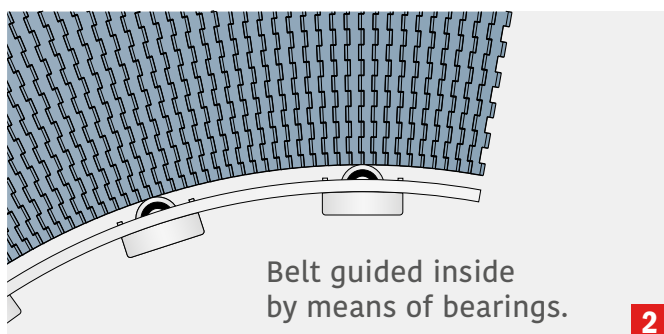
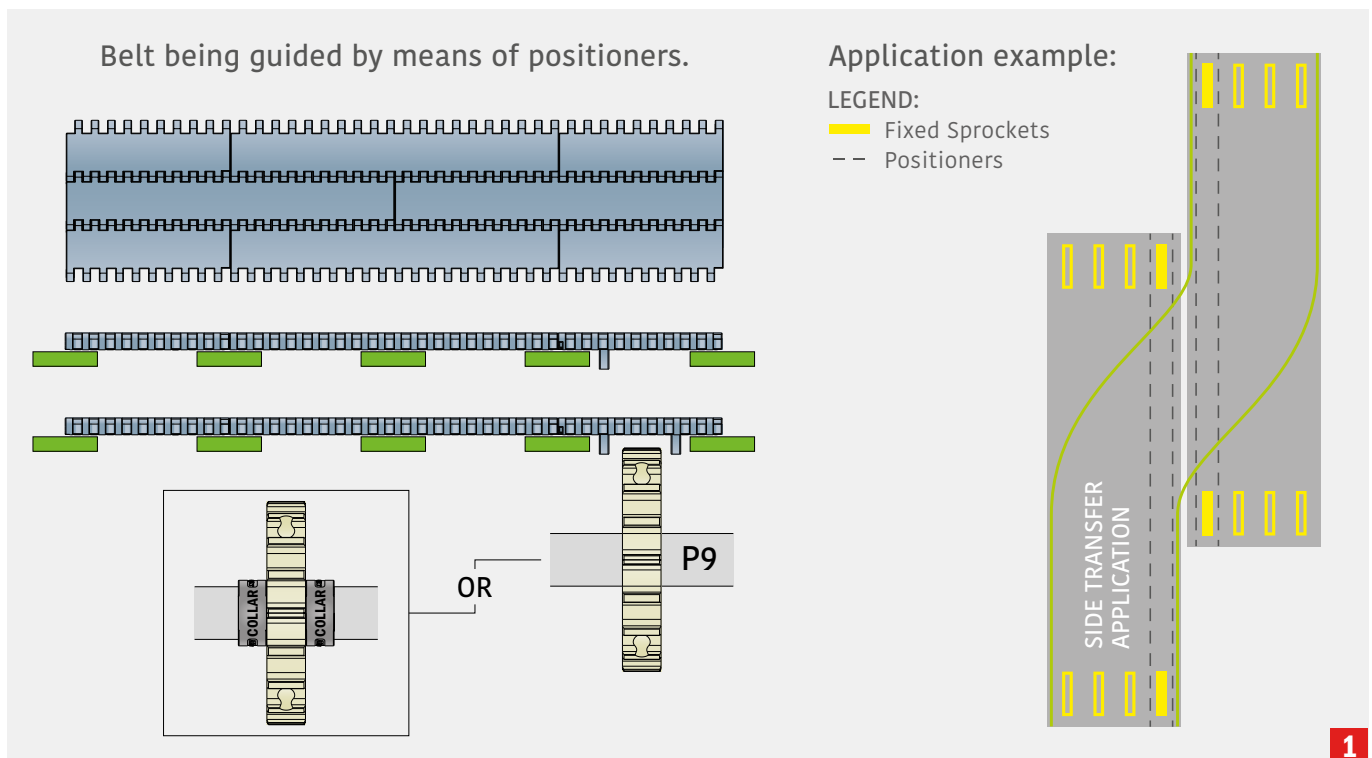

**Recommended max conveyor length**

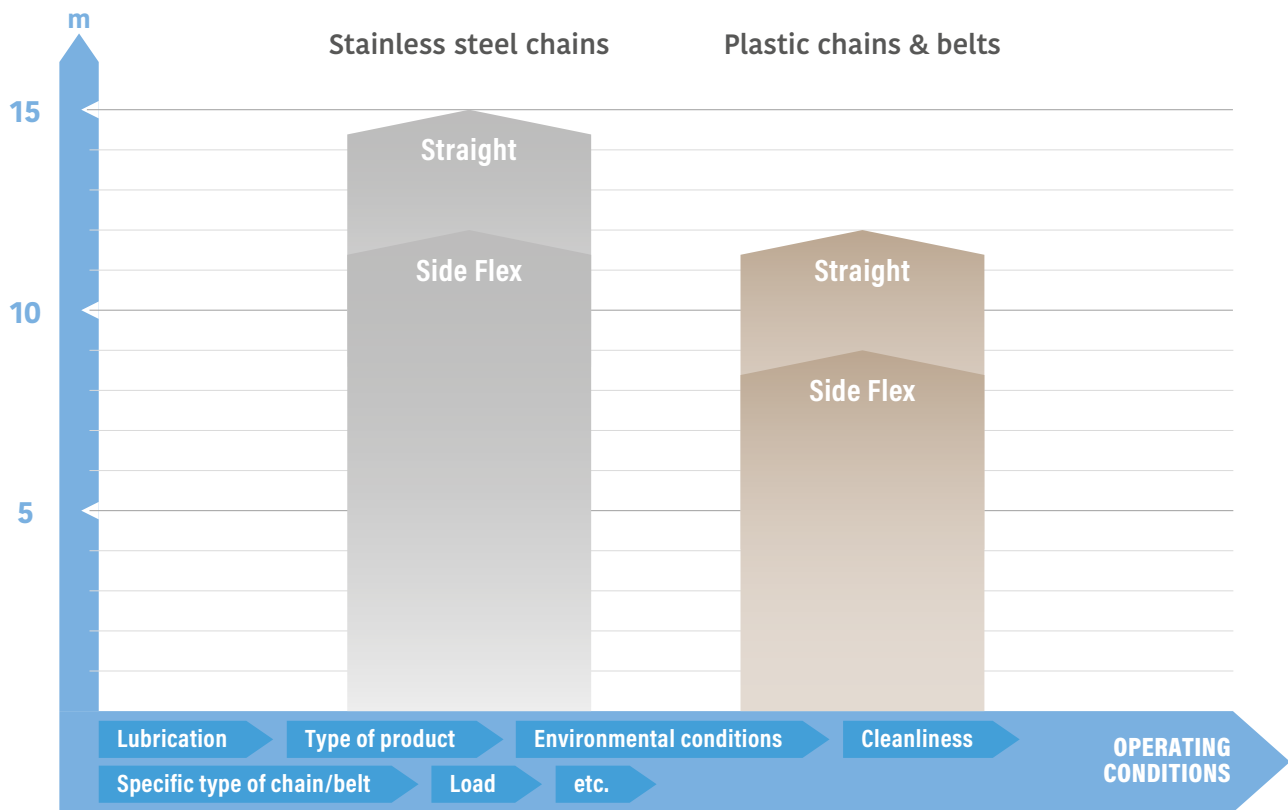

Note: these are only indicative figures. We recommend calculating the chain pull, anyway.

**Recommended max conveyor speed**

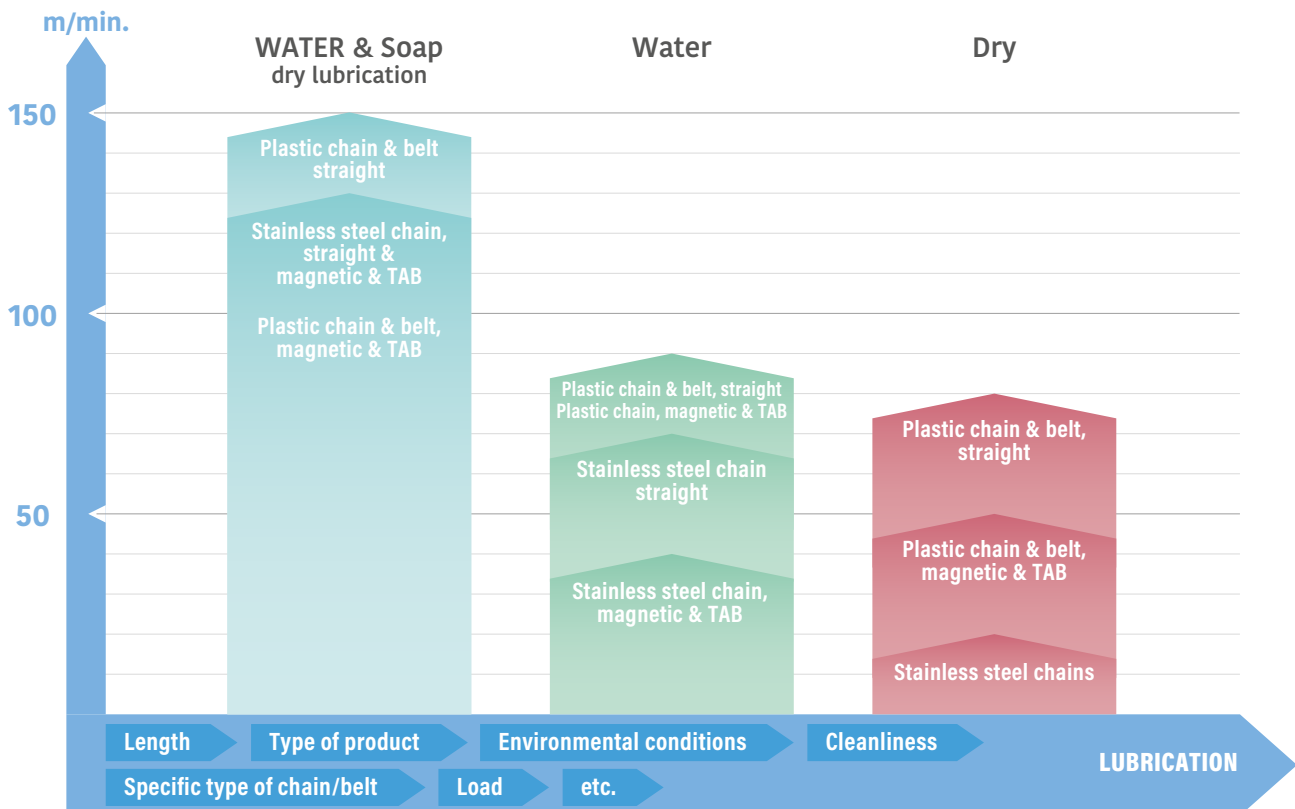

Note: these are only indicative figures. We recommend calculating the chain pull, pv, anyway.

## 2.5 Conveyor length and speed belts

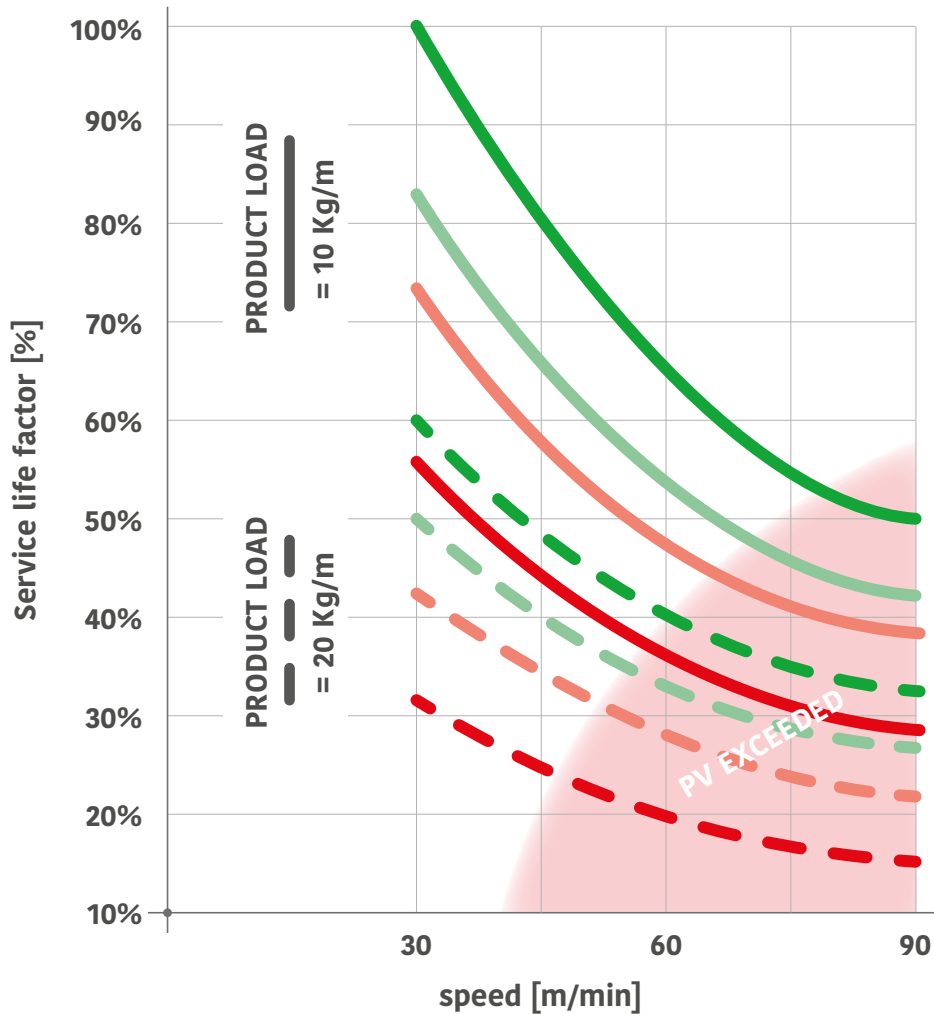

LEGEND:



Particularly for dry running chains/belts it is important to keep the entire conveyor in good and clean conditions.

Chain/belt service life factor is increasing with the combination of operating parameters:

- Dropping speed
- Dropping product load respectively chain pull
- Better cleanliness of the conveyor

The graph shows in a relative consideration the effect of certain grades of contamination under different speed and load conditions.

With lubrication the effect is less – graph lines are more flat and closer to each other. The risk of exceeded pv is clearly less.

Particularly the cleaning and cooling effect of wet lubrication contributes to elevate service life expectation.

## 2.6 Curve system - Bevel, Tab and Magnetic

LEGEND: ● Very good | ● Good | ● Satisfactory | ● Not good | ● Not available

### Bevel system

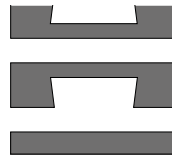
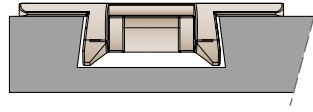

Chain retention	Chain easily removable	Easy cleaning	Easy maintenance	Product handling	Hygenic design	<i>RS</i> Version	<i>RS PRO</i> version	Self-cleaning version
●	●	●	●	●	●	●	●	●

### TAB system

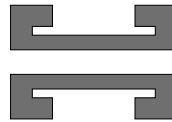
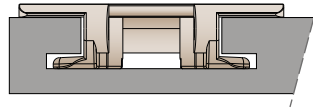

Chain retention	Chain easily removable	Easy cleaning	Easy maintenance	Product handling	Hygenic design	<i>RS</i> Version	<i>RS PRO</i> version	Self-cleaning version
●	●	●	●	●	●	●	●	●

### Magnetic system

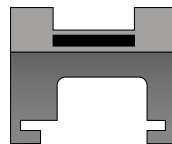
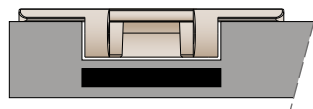

Chain retention	Chain easily removable	Easy cleaning	Easy maintenance	Product handling	Hygenic design	<i>RS</i> Version	<i>RS PRO</i> version	Self-cleaning version
●	●	●	●	●	●	●	●	●

### Return shoes for magnetic curves

in case of multitrack curves with staggered return tracks install return shoe matching the upper track level.

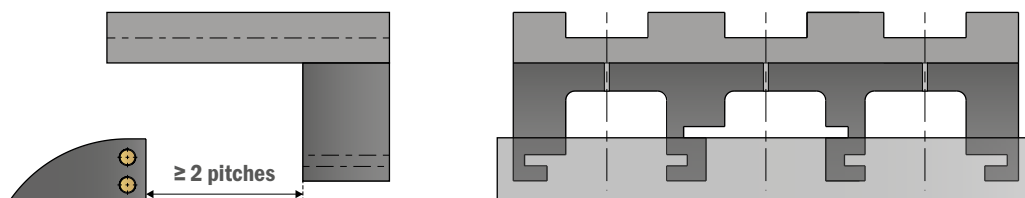

## 2.7 Drive design

### Head drive

Usually used for applications with only one permanent conveying direction.

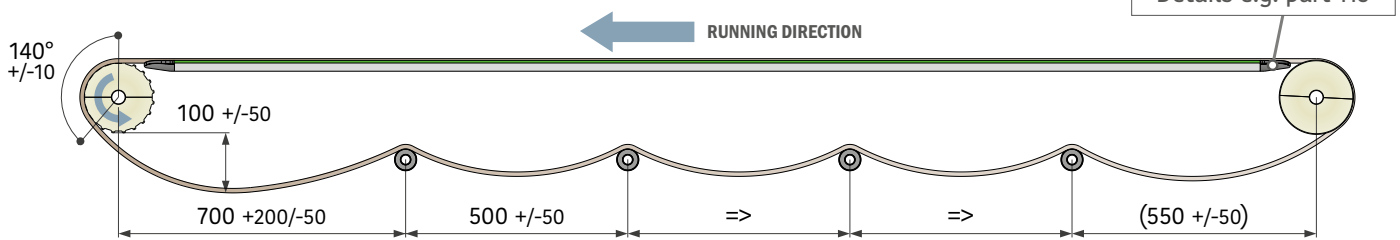

### Bottom head drive

Usually used for applications with only one permanent conveying direction and with requirements for short head to tail transfers.

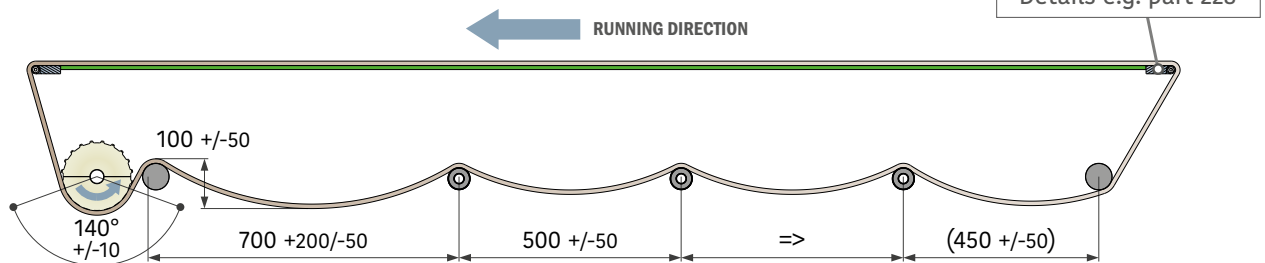

### Centre drive

Usually used for applications with reversible operating direction. In most cases it's necessary to install a suitable tensioning system.

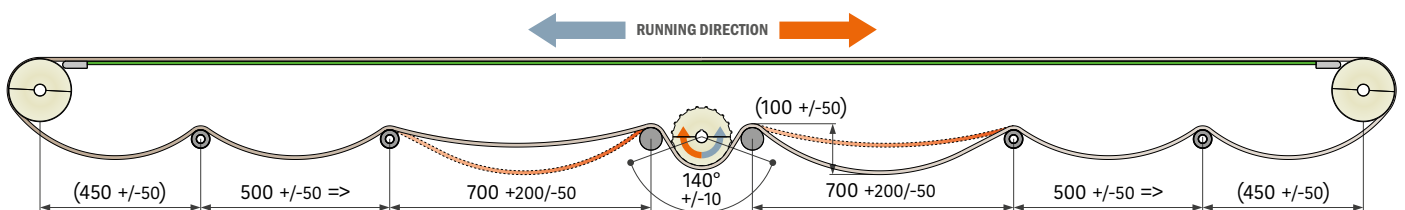

### Catenary sag maintenance

During installation, cut the length of a chain/belt in order to achieve a sag according to the nominal height H1.

When the sag reaches level 2

**ALARM LEVEL H2:** some links should be removed to get the chain/belt back to nominal height.

#### Suggested measures

(every application should be checked on a regular basis):

H1 - Nominal height: between 50 and 150 mm

H2 - Alarm height: bigger than 150 mm

It is responsibility to the OEM to determine and decide the correct level of the sag.

It is very important to provide to the end user simple ways to determine when the belt has to be shorten:

- Create a cut in the frame in order to give the end user a visual check
- Add sensors to give the end user an automatic/electronic alarm

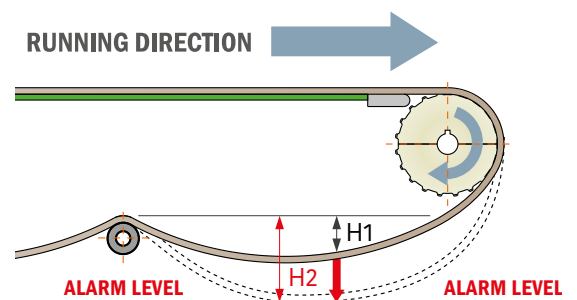



## 2.7 Drive design

### Tensioning options

If no regular catenary is applicable, tensioners are required. e.g., if catenary cannot be designed long enough. Same applicable to bottom head drive and centre drive.

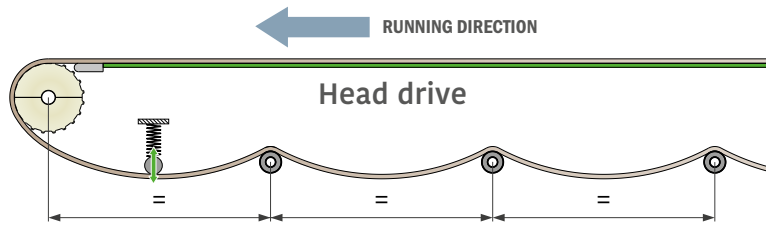

e.g., if the operating direction of the conveyor is reversible.

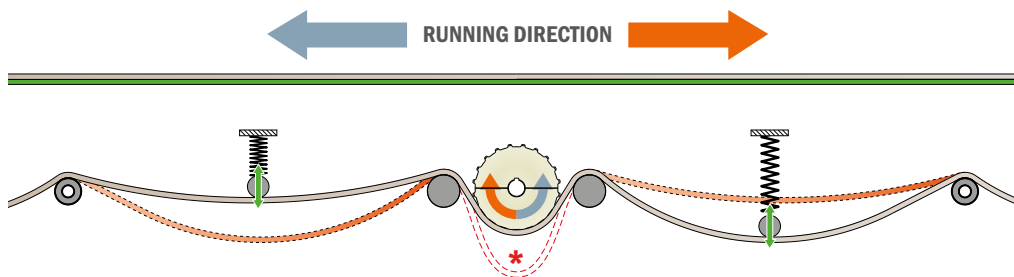

**\*Avoid chain/belt dropping off the sprockets.**

### Tensioning force calculation

Based on the fact, that already the gravity force of a chain/belt in the catenary is enough to create enough tension, the following approximation can be derived.

**In case of chains:**  $C_{bw}$  = chain weight [kg/m]

**in case of belts:**  $C_{bw}$  = belt weight [ $\text{kg}/\text{m}^2$ ] \* belt width [m]

**Real catenary length:**  $R_{cl}$  [m]

**Desired catenary length:**  $D_{cl}$  [m]; default value is 700 mm

**Tensioning force:**  $TF = C_{bw} * (D_{cl} - R_{cl}) * 9.81$  (gravity constant)

**Example:** LFA 550 FT belt,  $8.5 \text{ kg}/\text{m}^2$ , width 510 mm, real catenary length 350 mm.

$C_{bw} = 8.5 * 510 / 1000 = 16.67 \text{ kg}$   $TF = 16.67 * (700 - 350) / 1000 * 9.81 = \text{approx. } 57 \text{ N or } 5.8 \text{ kg}$

In this example, a tensioning device, located in the catenary section, would have to be adjusted to approx. 57 N. As a simple solution, a gravity roller could be placed in the catenary section, as well, with a weight of 5.8 kg.

Note: tensioning devices that are adjusted to higher rates create additional chain/belt load. Consequently, not only chains/belts, but all involved components (e.g. chain guides, curves, bearings) are higher loaded. This can lead to reduced performance and to reduced service life.

That's why it's recommended to follow the general basic rule: tension just enough, not more, not less.

## 2.8 Roller diameters

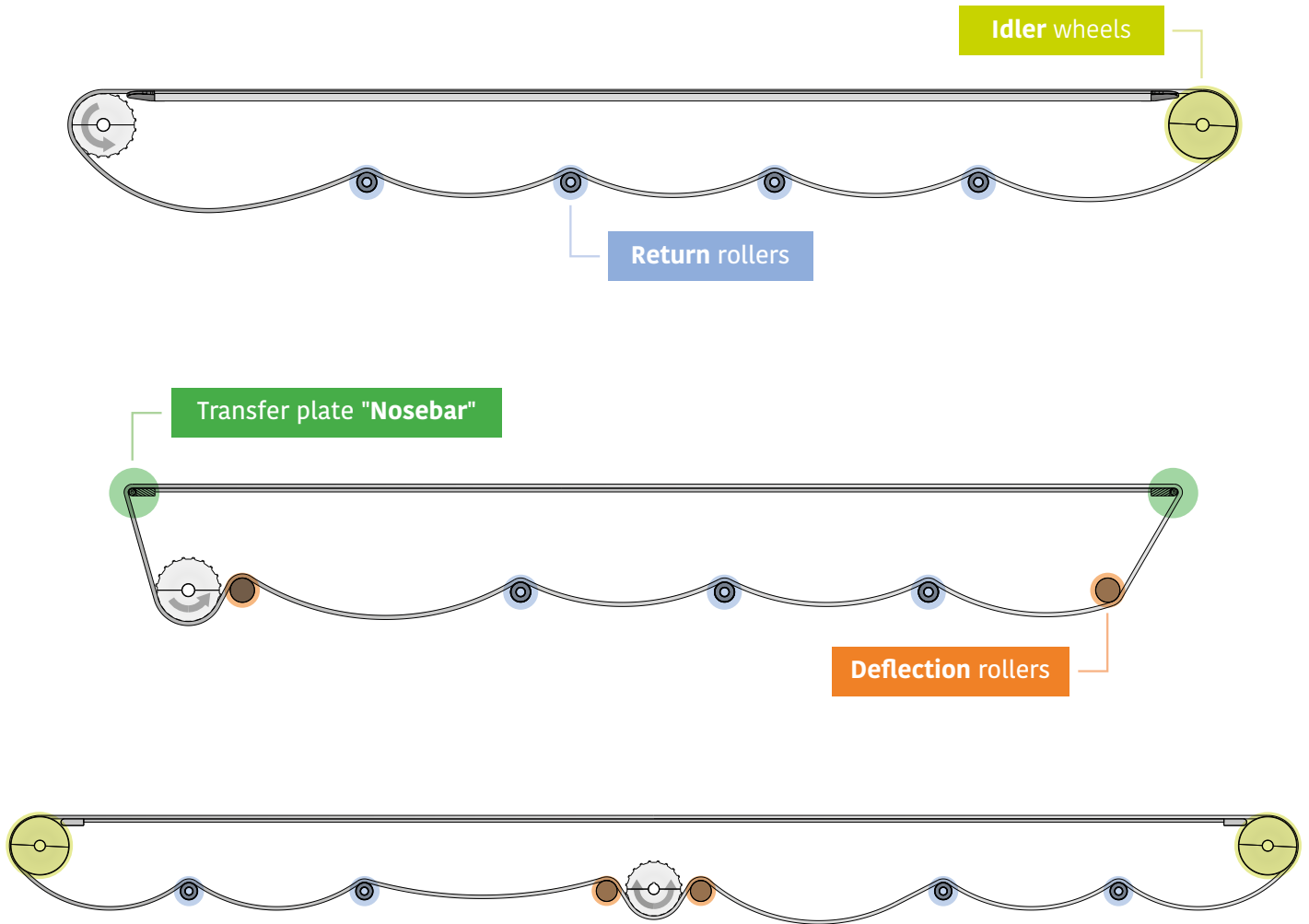

Unit of measurement (mm)		Chains		Belts							
				1/2" pitch		15 mm pitch		3/4" pitch	1" pitch		1 1/4" pitch
		LBP	Other	LBP	Other	LBP	Other	All	LBP	Other	All
<b>Idler</b>	<b>Nosebar</b>	D > 100		D > 19		D > 19		D > 40	D > 50		D > 50
<b>Return</b>		Sliding shoe	D > 50	Sliding shoe	D > 50	Sliding shoe	D > 50	D > 50	Sliding shoe	D > 50	D > 60
<b>Deflection</b>		D > (backflex radius + 10)*2 - Find backflex radius data in our catalogue.									



Example

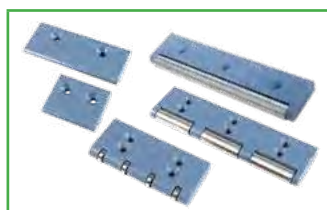

Example



Example



Example

## 2.9 Declined conveyors

$\alpha$  is the decline angle of the conveyor.  $\mu$  is the coefficient of friction between chain/belt and wear strip. If  $\tan(\alpha)$  is bigger than  $\mu$  the chain/belt, carrying product or not, might slip down towards the lower end of the conveyor.

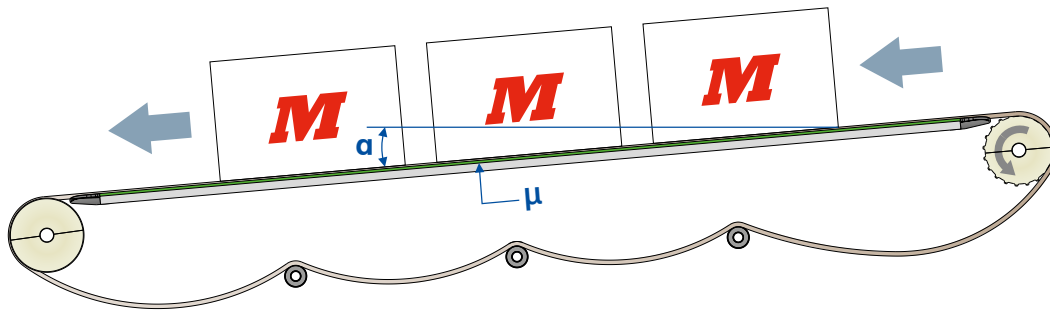

In order to keep the chain/belt under tension and avoid “tenting” the drive of the conveyor can be installed at the upper end of the conveyor.

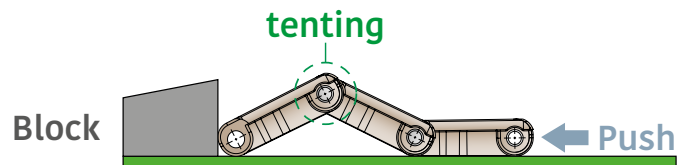

Alternatively, the drive can be installed at the lower end of the conveyor, as standard head drive, and the idler end, the upper end of the conveyor, can be equipped with a **brake**.

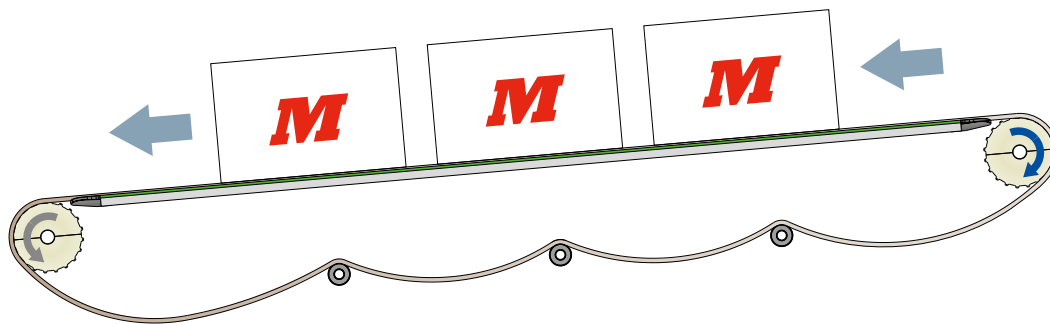

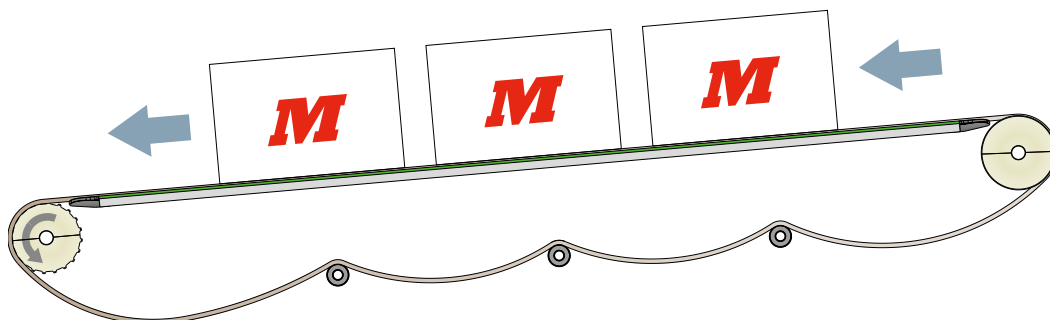

Standard head drive is possible up to maximum decline angle, under dry and clean operating conditions:



## 2.9 Declined conveyors

Chain belt material	Coefficient of friction			Max decline angle $\alpha$ [°]		
	Wear strip material			$1/\tan(\alpha)$		
	Stainless steel	UHMW-PE PA	BluLub	Stainless steel	UHMW-PE PA	BluLub
<b>MX</b>	0,20	0,16	0,13	11	9	7
<b>LF - MWX - DKM</b>	0,24	0,20	0,18	13	11	10
<b>PP - PPX</b>	0,29	0,24	0,21	16	13	12
<b>SS</b>		0,35	0,32		19	18
<b>SSE - SSM - SSA</b>		0,33	0,30		18	17

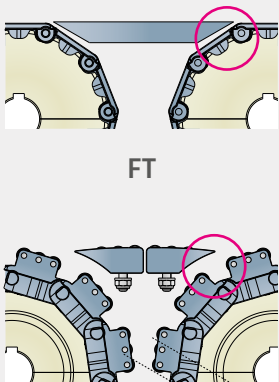
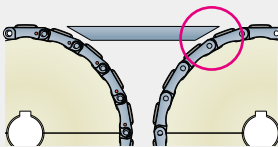
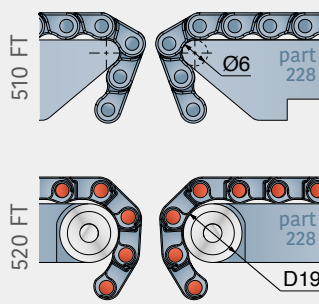
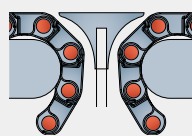
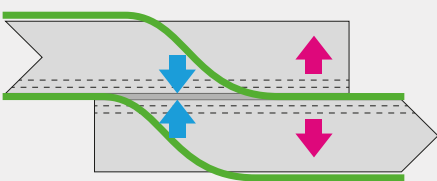
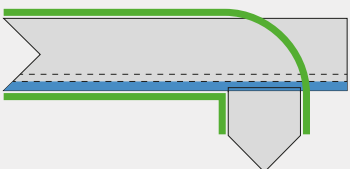
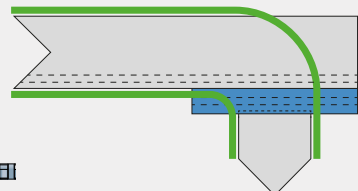
## 2.10 Transfer

	Chains	Belts	Belts with small pitch																								
			e.g. 510 / 520/ 525HD & 530 Series																								
Head-to-tail	<b>With standard transfer component</b>  FT LBP	 GT <b>Clearance</b> must be enough to avoid touching of chain/belt surface respectively chain/belt attachments with transfer component.	<b>Without transfer plate</b>  510 FT 520 FT or with standard transfer component.																								
			<b>With transfer profile</b>  or with standard transfer component.																								
			<b>Possible shortest gaps for 520 belt series</b> <table border="1"> <thead> <tr> <th>Belt 1</th> <th>Belt 2</th> <th>A (mm)</th> <th>Belt 1</th> <th>Belt 2</th> <th>A (mm)</th> </tr> </thead> <tbody> <tr> <td>FT/ FG</td> <td>FT/ FG</td> <td>40</td> <td>GT</td> <td>GT</td> <td>44</td> </tr> <tr> <td>FT/ FG</td> <td>GT</td> <td>42</td> <td>GT</td> <td>LBP</td> <td>55</td> </tr> <tr> <td>FT/ FG</td> <td>LBP</td> <td>53</td> <td>LBP</td> <td>LBP</td> <td>65</td> </tr> </tbody> </table>	Belt 1	Belt 2	A (mm)	Belt 1	Belt 2	A (mm)	FT/ FG	FT/ FG	40	GT	GT	44	FT/ FG	GT	42	GT	LBP	55	FT/ FG	LBP	53	LBP	LBP	65
Belt 1	Belt 2	A (mm)	Belt 1	Belt 2	A (mm)																						
FT/ FG	FT/ FG	40	GT	GT	44																						
FT/ FG	GT	42	GT	LBP	55																						
FT/ FG	LBP	53	LBP	LBP	65																						
Side "S-transfer"	Chains are guided with their hinges.		For belts it's recommended to guide them with their positioners. Dashed line marks the recommended position of positioners to achieve a defined gap between the belts. Consider belt width expansion starting from the positioner line.																								
90° transfer		<b>Wide belt with integrated transfer wings</b> 	<b>Intermediate transfer wing belt</b>  e.g. 550 FTT 																								

## 2.11 FTT Transfer

For 90° transfers with belts with integrated transfer wings, versions FTT-CN and FTT-SX, the space for belt support, e.g. by means of wear strips, is limited. Find in attached table and sketch the available space dimensions.

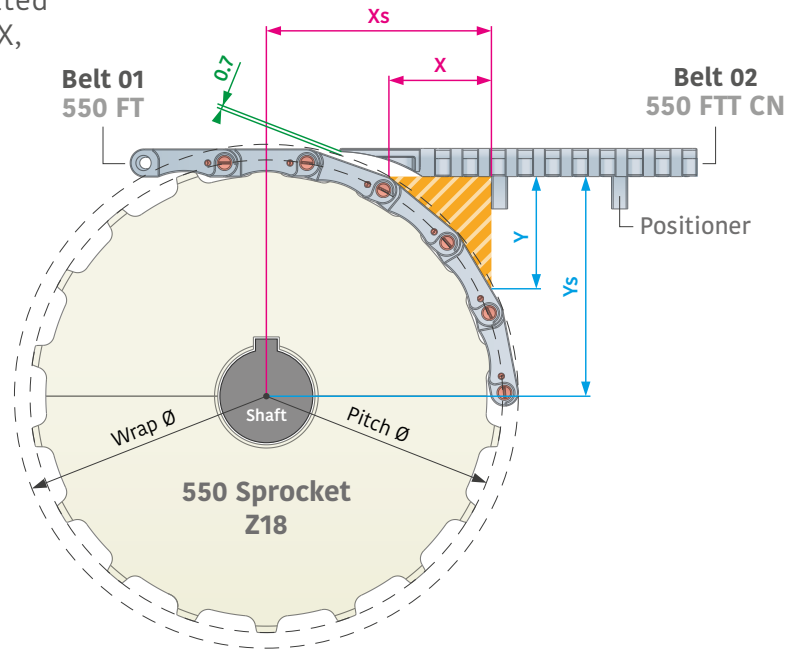

Belt 01 (Series)	Belt 02 (Series)	Sprockets (Z)	X (mm)	Y (mm)	Xs (mm)	Ys (mm)
550	550 FTT-CN	14	29,69	47,75	61,20	52,7
550	550 FTT-CN	16	28,04	28,87	61,70	60,75
550	550 FTT-CN	18	27,02	23,25	62,70	68,8
550	550 FTT-CN	20	26,11	19,74	63,70	76,85
520	520 FTT-CN	28	28,54	40,81	59,95	52,35
520	520 FTT-CN	36	25,85	21,77	61,45	68,5
520	520 FTT-CN	38	25,37	19,98	61,95	72,55
520	520 FTT-CN	40	24,92	18,50	62,45	76,6
590	590 FTT-SX	17	62,70	n.a.	92,30	46
590	590 FTT-SX	21	60,70	n.a.	93,81	58,65
590	590 FTT-SX	24	59,50	n.a.	94,76	67,1
590	590 FTT-SX	25	59,10	n.a.	95,10	70,15
525	525 FTT-CN	12	36,67	n.a.	59,15	24,7
525	525 FTT-CN	16	34,75	n.a.	60,65	34,2
525	525 FTT-CN	24	31,53	n.a.	63,15	53,1
525	525 FTT-CN	32	28,62	24,14	65,15	72,35
551	551 FTT-CN	11	43,10	n.a.	76,95	38,75
551	551 FTT-CN	14	40,67	n.a.	78,75	50,75
551	551 FTT-CN	16	38,59	n.a.	79,25	58,75
551	551 FTT-CN	18	37,15	n.a.	80,25	66,8
551	551 FTT-CN	20	35,34	41,02	80,75	74,85
551	551 FTT-CN	21	34,73	36,66	81,25	78,85
552	552 FTT-SX	16	56,40	n.a.	97,06	58,75
552	552 FTT-SX	18	54,80	n.a.	97,90	66,8
552	552 FTT-SX	21	52,60	n.a.	99,12	78,85
552	552 FTT-SX	25	49,90	56,64	100,64	95

Example in the above drawing

n.a. means that the wrap radius is smaller than the Xs-distance from shaft center to the positioner.

## 2.12 Wear strip

### Typical wear strip construction

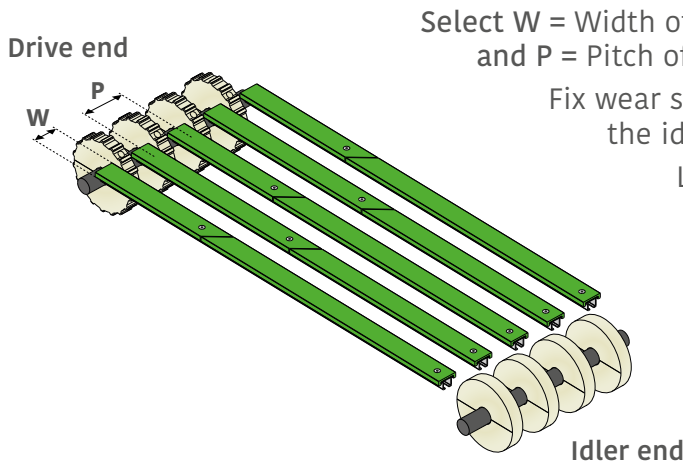

Select  $W$  = Width of wear strip  
and  $P$  = Pitch of wear strips according to your conveyor design.

Fix wear strips only at their end looking towards the idler end of the conveyor.

Leave the other end loose.

This enables the wear strip to expand.

For wear strip connections it's important to install enough clearance between the ends in order to enable expansion.

Clearance = 6 to 10 mm

Find heat expansion calculation advice in the materials chapter.

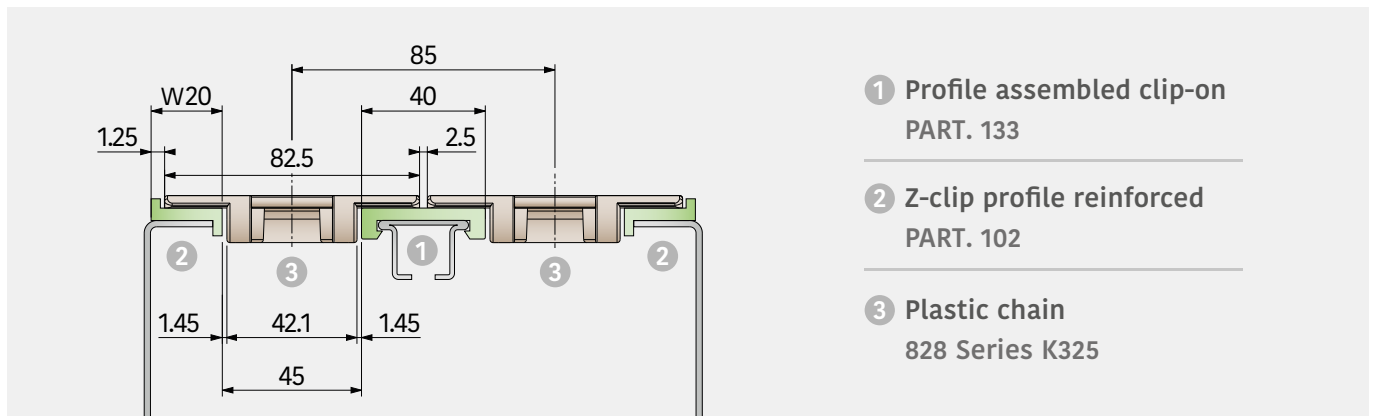
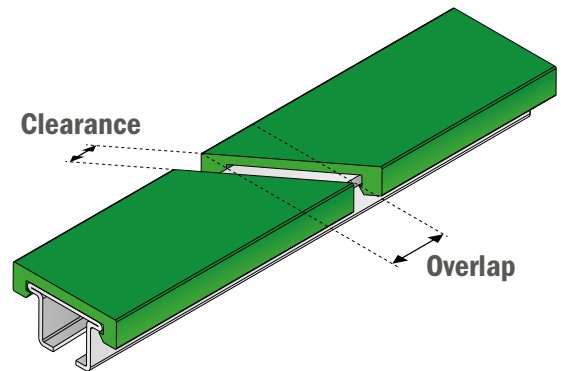

Chamfer the ends or better install wear strip shoes to reduce chordal action and run chains/belts smoothly on/off wear strips.

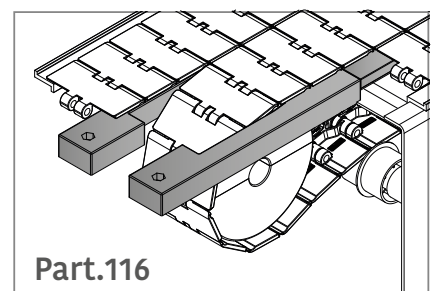
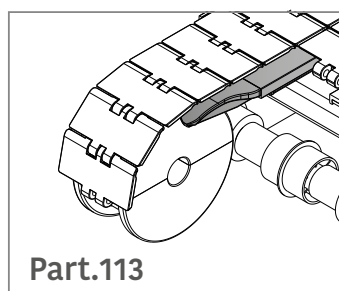
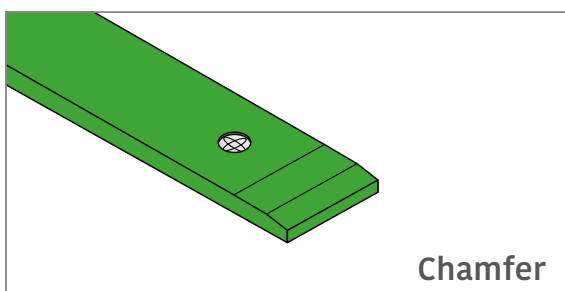

## 2.12 Wear strip

Special wear strips for transfers between chains and belts with different plate thickness.

Note: Movex can provide these products on request.

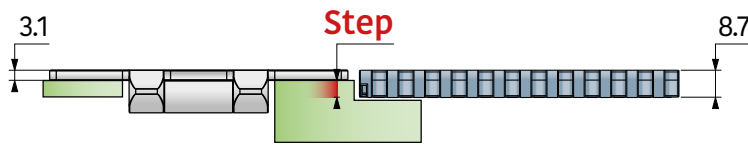

### Modular Belts VS

Plate thickness (mm)

8.7

### Modular Belts

Plate thickness (mm)

12.7 / **Step 4.0**

Example: 815 steel chain vs 550 modular belt

Steel chains VS	Plastic chains	Modular Belts
Plate thickness (mm)	Plate thickness (mm)	Plate thickness (mm)
3.1	4.0 / <b>Step 0.9</b>	8.7 / <b>Step 5.6</b>
	4.8 / <b>Step 1.7</b>	12.7 / <b>Step 9.6</b>

### Plastic chains VS

Plate thickness (mm)

4.0

4.8

### Modular Belts

Plate thickness (mm)

8.7 / **Step 4.7**

12.7 / **Step 8.7**

8.7 / **Step 3.9**

12.7 / **Step 7.9**

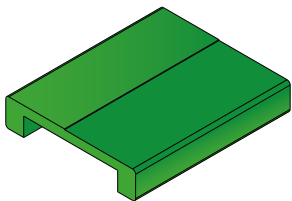

### U-profile staggered version. Part. 199

Staggered wear strips are recommended for applications where sensitive products move across chains/belts, e.g. inliners, outliners, ejector tables.

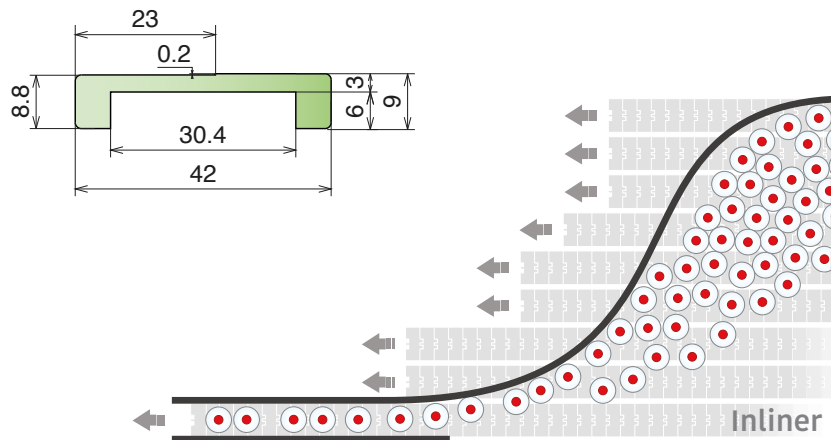
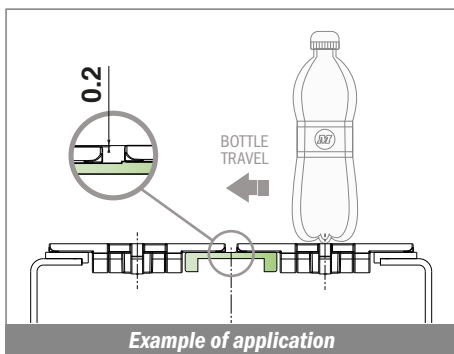







## 2.13 Selection of wear strip material, guideline





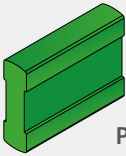

LEGEND: ● Good | ● Limited | ● Not recommended

Wear strip material	Steel chains		Plastic chains and Belts	
	Lubricated	Dry	Lubricated	Lubricated
* Movex standard				
UHMW-PE*	●	●	●	●
BluLub*	●	●**	●	●
PA	●	●	●	●
SS	●	●	●	●
Steel	●	●	●	●

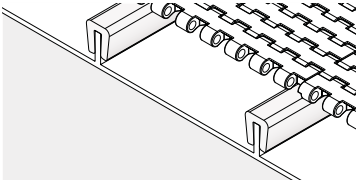
\*\* Recommended for higher speed and/or higher product load.

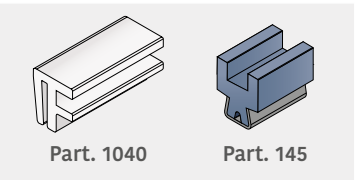
## 2.14 Return systems for standard applications

	Rollers	Shoes	Serpetines
Typical components			
Typical applications			
Principle	Rolling	Rolling (e.g. LBP chains/belts) & Sliding (FT, FG chains/belts)	Sliding
Notes	Big diameter recommended	Big radius	Keep distance between supports short
May create wear, if	Rollers are blocked	Not expected	Not clean
Open support	YES	YES	YES
Full support	NO	NO	YES
Advantages	Rubber coating reduces noise and slip against chain/belt	Particularly suitable for products with big back-flex radius	Low noise
Typically used for	Straight conveyor sections as a standard system	LBP	Plastic chains/belts

	Profiles*	TAB chains	Side-flex belts
Typical components			
Typical applications			
Principle	Sliding	Sliding	Sliding
Notes	Steel carrier profile required	May create higher chain pull (Consider BluLub)	Additional support profiles* required for belts wider than 170mm
May create wear, if	Not clean (may create wear tracks at chain/belt surface in the area of supports)	Not clean (at TABs)	Support profiles* are installed
Open support	YES	YES	YES
Full support	NO	NO	YES with *
Advantages	Low noise & Simple construction	Low noise & Simple construction	Low noise & Simple construction
Typically used for	Side-flexing belts	TAB chains	Side-flexing belts



## 2.14 Return systems for standard applications

### Open support system

Return systems, as shown in previous overview, are open and help to get dirt and debris ejected from the conveyor.



Example of what happens if return rollers are blocked.

### Massive scratches

Example of what happens if sliding return is contaminated.

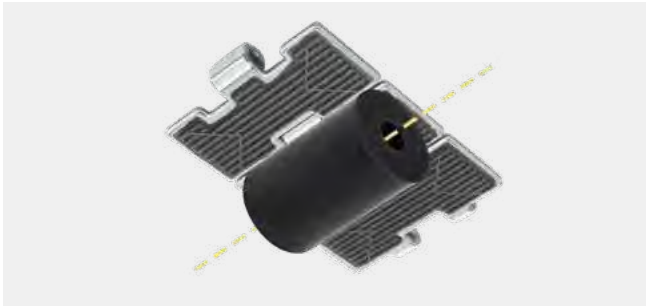

For GT chain/belt versions return rollers are recommended.

With side-indent GT version also sliding return is applicable.

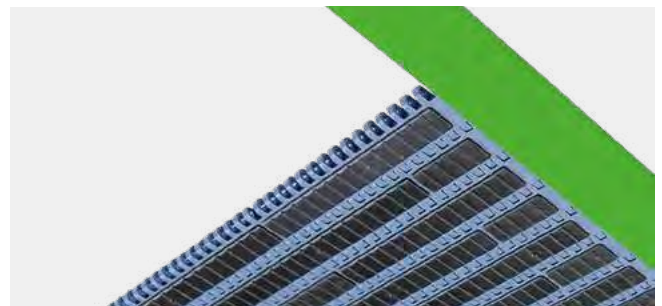
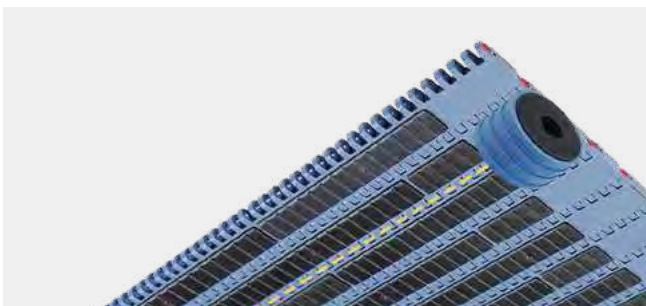
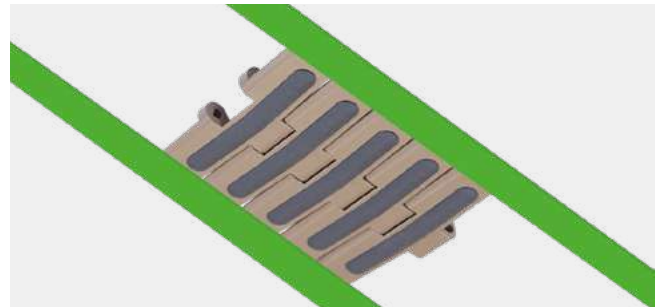
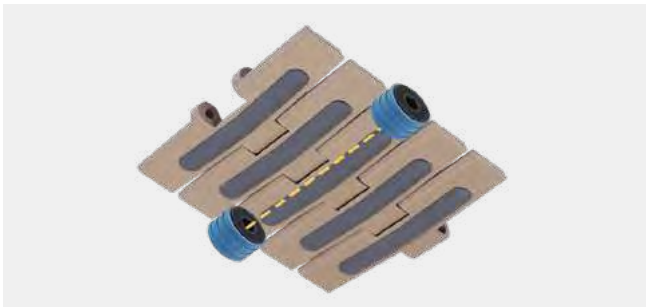
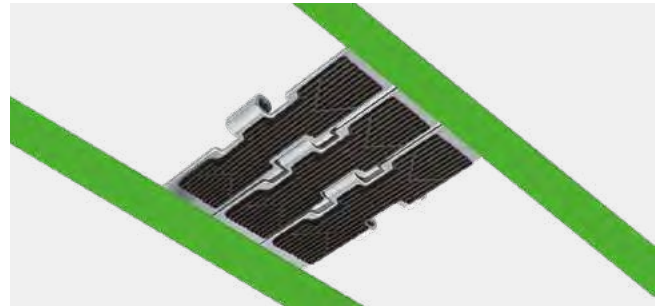
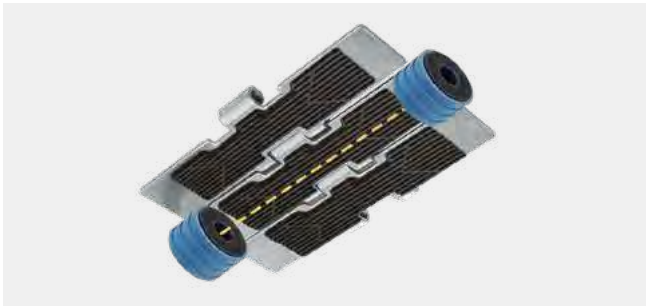

**GRIPPER  
CHAIN**

***Movex***

# GRIPPER CHAIN

3.1	Recommedations for installations & maintenance .....	84
3.2	Selection guides .....	90
3.3	Checklist and protocol for gripper chain conveyor inspection .....	91

### Adjust chain tracks parallel with a tolerance of < 2 mm

Incorrect adjustment can lead to wear at grippers, flights and roller chain.

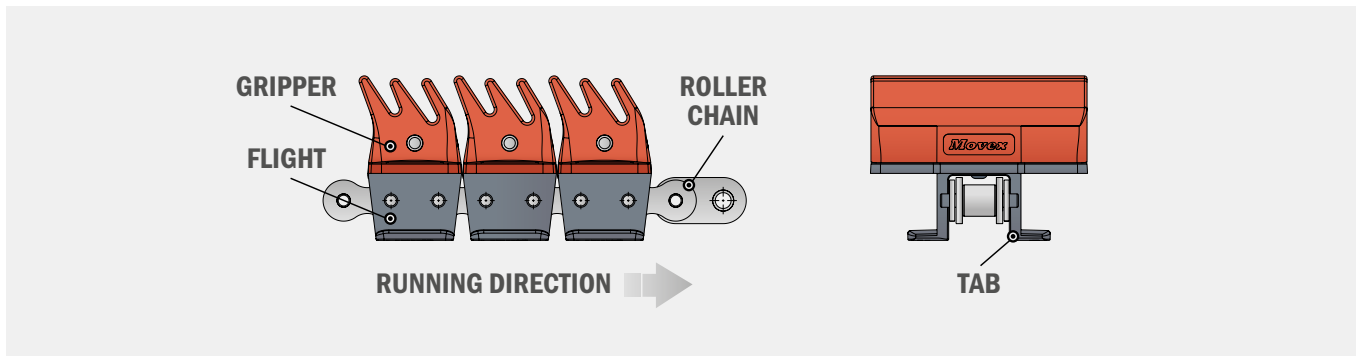

### Gripper ribs must be oriented backwards relative to the running direction of the chain

Running the chain in reverse direction can damage grippers, flights and roller chain.

### Product accumulation is not allowed

This has the same effect as running the chain in reverse direction.

### Tension the chain carefully

Procedure:

- Take out the play of the chain by means of the tensioning device.
- Release the chain just by reducing the tensioning force a little.

Note: any pre-tension in the chain will increase the resulting chain pull enormously and will lead to wear/elongation at the roller chain.

Particularly with automatic/pneumatically driven tensioning devices the adjustment has to be done very carefully. Reduce the air pressure to the minimum required amount.

In order to avoid over-pre-tensioning by automatic tensioners, it is recommended to install a mechanical limiter.

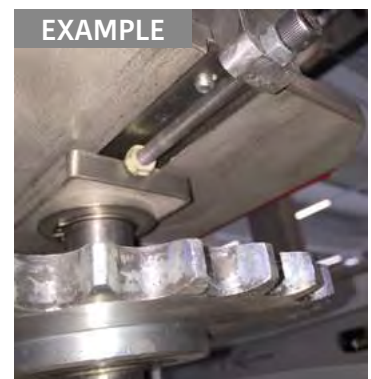

### Clearance between chain tracks must be adjustable

- Adjustment of the gripping force must be possible.
- Always double-check the clamping force: the product must be removable by hand.

General rule: clamp the product as tight as necessary and as loose as possible. Too high clamping forces can lead to damage at grippers, flights and roller chain. Too low clamping forces can lead to product falling off the conveyor causing a crash or other damage.

### Both chain strands must run at the same speed

A speed differential will lead to turning products while they're clamped between the chains and obviously to damage at grippers, flights and roller chain.

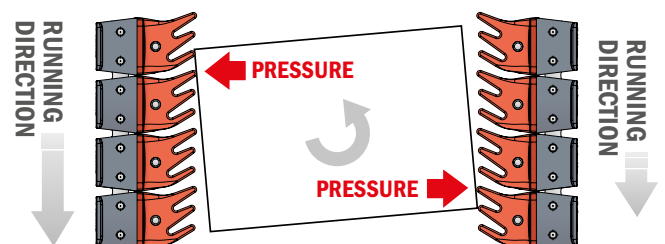

### BluLub

Consider **BluLub** chain guide/curve material in order to reduce friction and chain pull and all resulting effects. Consider **RS** version for simplified maintenance.

### 3.1 Gripper chain - Recommendations for installation & maintenance

Touching products must be avoided (particularly in curves)

There must be enough gap between products.

If products touch each other, grippers, flights and roller chain can be damaged.

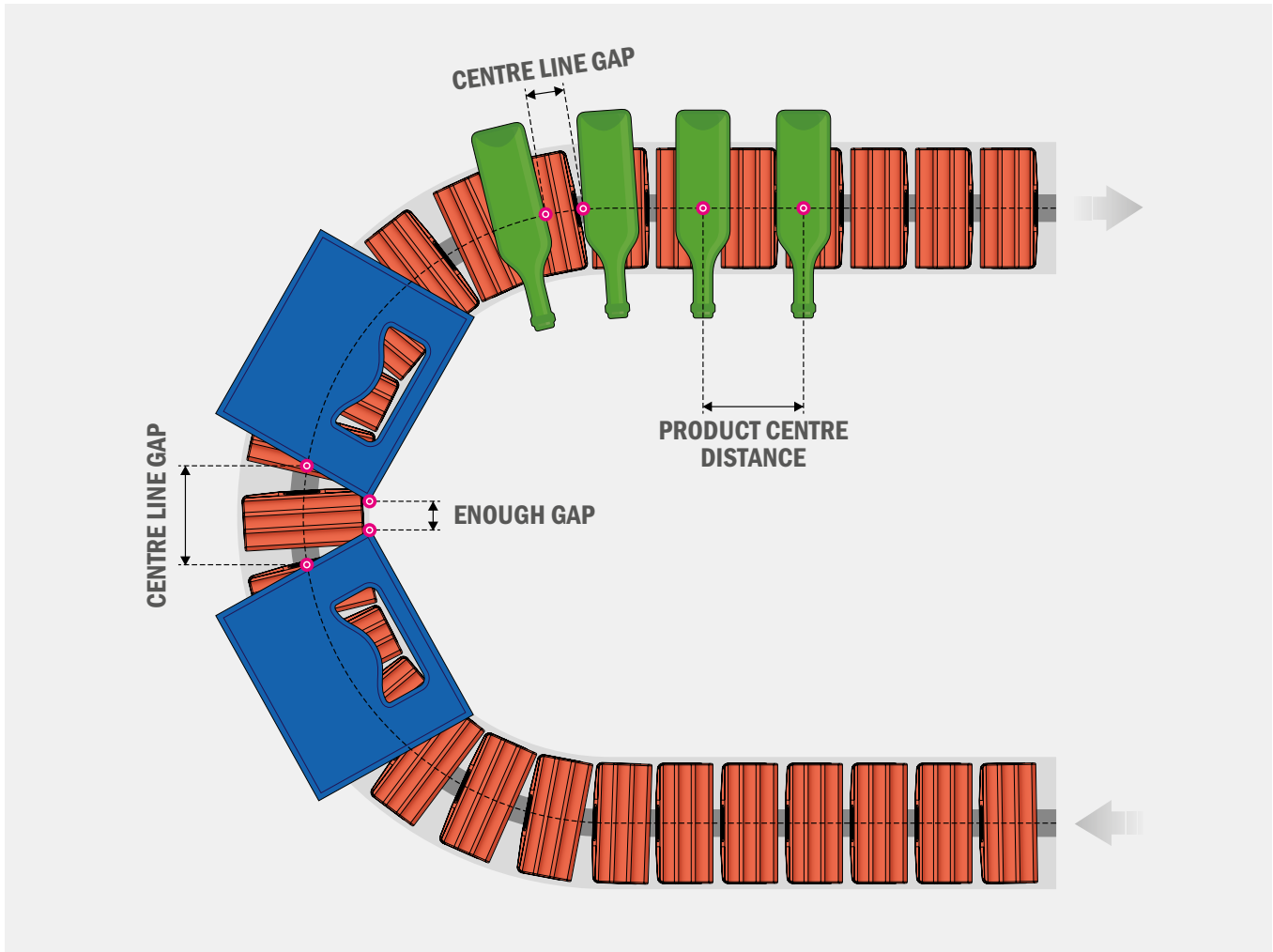

#### Lubricate the roller chain to achieve a better service life

C45 roller chains have to be lubricated to avoid corrosion, anyway. Apply lubrication in the friction zone between flights and chain guides/curves, if required, respectively, if chain pull is approaching a critical value or if pv-limits are approached.

Install e.g. perma-lube-tins.



## 3.1 Gripper chain - Recommendations for installation & maintenance

Select the right gripper version for your conveying task:

### GS1 Version

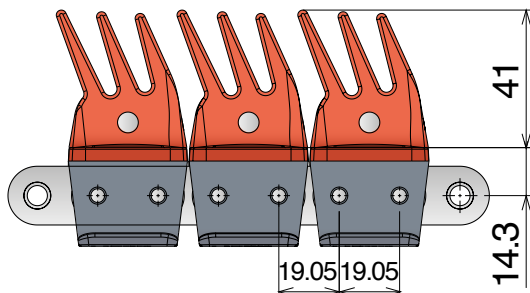

Ideal for transporting:  
Soft containers, PET bottles, Cans  
Bottles without pressure.

### GS2 Version

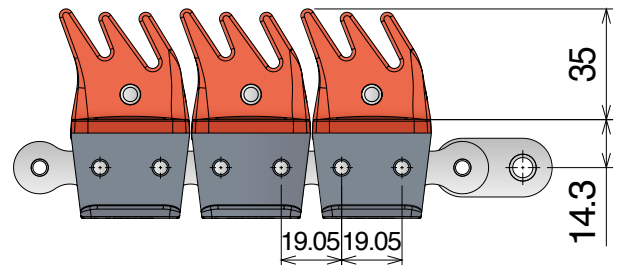

Ideal for transporting:  
Solid containers, Crates,  
Glass bottles.

### GS4 Version

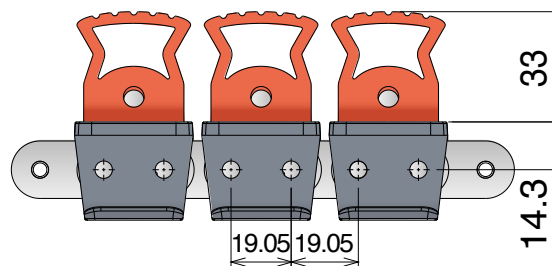

Ideal for transporting:  
Small containers.

### Replacing or installing gripper-flights

- Put the roller chain onto the flights with the extended pins matching the grooves at the TABs of the flights. Don't hammer directly on the roller chain – use a wooden or plastic bar! Hammer softly! The extended pins must flip into the bores at the end of the grooves at the TABs.
- For installing a gripper onto a flight respect the assembly direction of the gripper mounting pin. Put the gripper onto the flight. Press in the pin softly!



In case of difficulty, you can heat up the flight. But not too much! Hot air not warmer than 60°C! This will make the flight more elastic and so it will flip more easily onto the roller chain.

## 3.1 Gripper chain - Recommendations for installation & maintenance

### Keep gripper chain conveyors clean

#### Further checks

- While pulling in a new gripper chain into the conveyor particularly check the chain guides for collision points. The chain must slide free!
- Check and re-adjust the tension of the gripper chain on a regular basis.
- Check curve wear on a regular basis. The wear limit of curves is reached, if the inner edge of the flight is 3 mm away from the inner edge of the curve.
- Check flight wear on a regular basis. Flights are worn, if the extended pins of the roller chain are close to reaching the surface of the TABs or, if the flight plate is worn down to 50% of the original thickness.
- Check roller chain elongation on a regular basis.  
Pitch limit = nominal pitch + 3%:  $19,05 * 1,03 = 19,62$  mm.
- Check grippers on a regular basis. If gripper ribs height is worn more than 1 mm, readjust the distance between the two chain strands in order to keep clamping forces ok. The wear limit of grippers is reached, if they lose their elasticity – their spring properties to hold the product safely. Replace lost grippers immediately.



#### Power consumption

- Read the power consumption for each drive on a regular basis:  
**Increasing** values indicate increasing resistance of the chain sliding through the conveyor.

##### Possible reasons are:

1. Too tight adjusted distance between chains strands.
2. Tensioning system is applying too much force.
3. Dirt has accumulated in the conveyor.
4. Chain guides/curves are worn.
5. Check chain and conveyor immediately to avoid further trouble.

- **Decreasing** values indicate reducing sliding resistance through the conveyor.

##### Possible reasons are:

1. Too loose adjusted distance between chains strands, products might fall off.
2. Tensioning system is not active, has to be readjusted according to chain elongation.
3. Check conveyor adjustments immediately to avoid further trouble.

## 3.1 Gripper chain - Recommendations for installation & maintenance

### Working load of roller chain

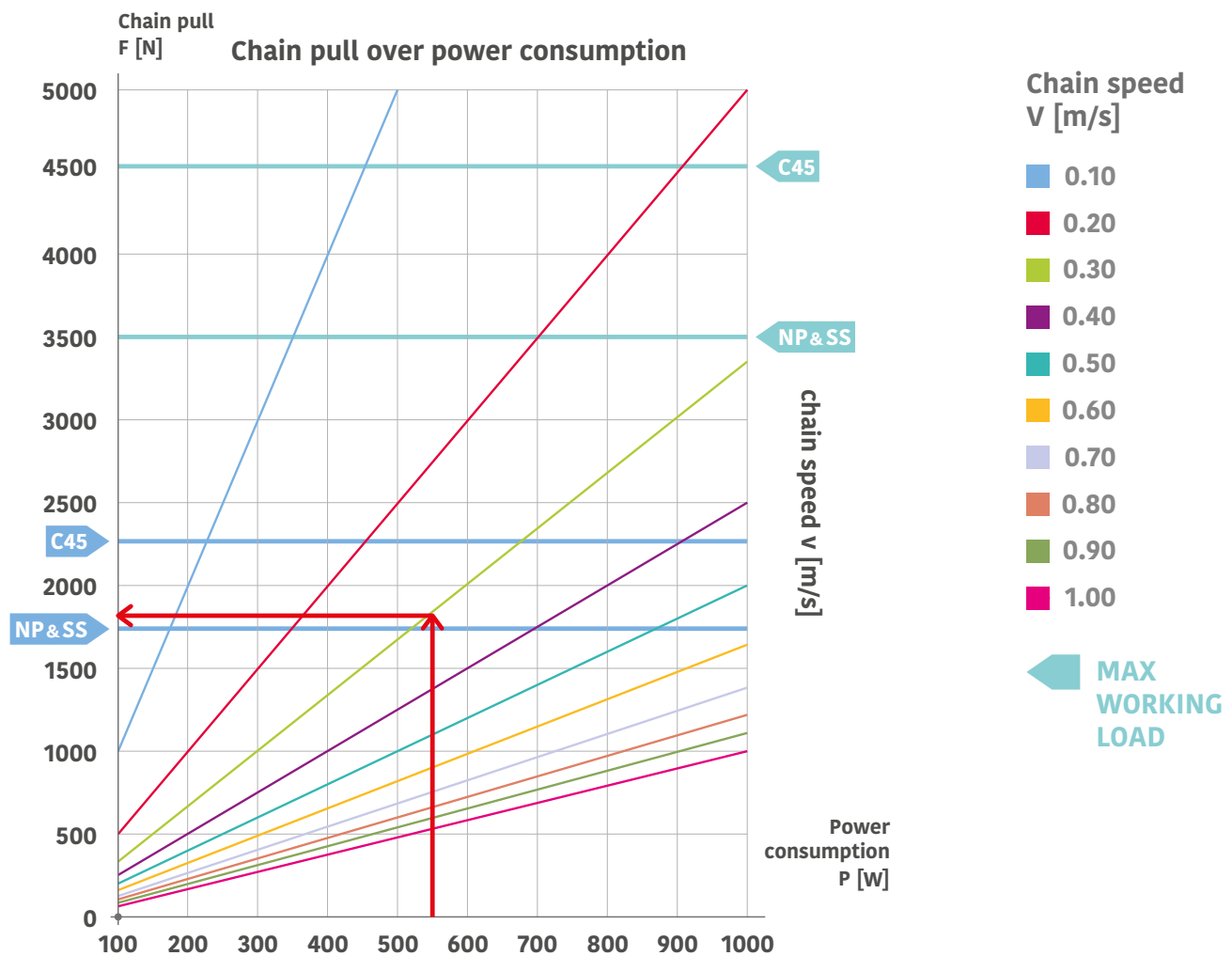

Already during commissioning the power consumption of each drive is a good indicator for a smooth run of the chain. The above graph helps to determine the actual chain pull and to compare it with the admissible working load of the roller chain.

**Example:** chain speed is 0,3 m/s, power consumption of the drive is 550 W. The chain pull is approx. 1850 N. The working load limit of a nickel plated roller chain as well as of a stainless steel roller chain is 3500 N, of a C45 roller chain 4500 N.

**Result:** the determined chain pull in operation is ok with respect to admissible working load limits.

**Important:** gripper chain applications are subject to unforeseeable variation of operating parameters. That's why gripper chain applications have to be supervised very carefully and maintenance has to be done regularly and thoroughly. In order to consider alternating operating parameters (e.g. adjustment of the clamping width/distance between the chain strands, tensioning forces, cleanliness, wear, product changes/different product dimensions, environmental conditions/temperature, etc.) it is strongly recommended to stay below 50% of the admissible working load.

**In that example this means: SS and NP roller chains are slightly over the recommended limit, C45 roller chain is still ok.** It is recommended to record power consumption values on a regular basis and determine the best working value after a certain supervision period.



## 3.1 Gripper chain - Recommendations for installation & maintenance

### Further recommendations

- Same as increased/decreased power consumption values, also alternating power consumption values require special attention. Power consumption should be constant over a full revolution of the chain through the conveyor. Peaks indicate problems with flights or roller chain links. Alternating readings indicate collision points between chain and guides.
- For the conveyor design it is generally recommended to avoid total sliding curve angles of more than 180°. If more curves are required it is strongly recommended to install curve wheels instead of sliding curves. Total sliding angle of more than 180° can lead to chain overload, rapid wear, exceeded pv, damaged chain and guides.
- In case that a Movex gripper chain is installed to replace a competitive product, it is important to re-adjust the clamping width of the conveyor. Gripper height might be different!
- It's always necessary to find out the type and materials of the old chain. At the same time it's necessary to understand clearly, if there were problems with the old chain and to specify precisely what kind of improvement the customer expects. Only with that information it's possible to determine the most promising chain type.
- In case that a Movex gripper chain is installed to replace a competitive product, it is important to re-adjust the clamping width of the conveyor. Gripper height might be different!
- It's always necessary to find out the type and materials of the old chain. At the same time it's necessary to understand clearly, if there were problems with the old chain and to specify precisely what kind of improvement the customer expects. Only with that information it's possible to determine the most promising chain type.
- Check the chain for any kind of damage and for embedded foreign pieces/particles. Clean or replace gripper flights, if necessary. Also check the chain for crash marks and find the source, e.g. a clamped bottle or a collision point with the conveyor bed.
- Check the entire conveyor and the floor underneath and around for cut off plastic chips, metal pieces/swarf, foreign particles /parts, etc. Chips are always an indicator for collision points between chain and conveyor bed. They also indicate exceeded pv-limit/overheating.
- Check the curve temperature at the sliding surface between TABs and curve. The value should be lower than 45°C.
- For gripper chain applications in wet environment generally stainless steel roller chains are recommended. C45 roller chains might be necessary due to load considerations, but obviously need lubrication mainly for corrosion protection. This has to be checked carefully.
- With gripper chain applications in wet & hot environment, e.g. bottle disinfectors, the elevated temperature level has to be considered on top of the wet circumstances. Lubricants get washed out and so the friction in the entire system just like the load on the chain is running at an elevated level. Stainless steel roller chains are generally recommended. More rapidly taking place wear has to be expected.
- Always consider chemical compatibility of chain and chain guides with chemicals:
  - 1) All kinds of cleaning chemicals
  - 2) All kinds of process chemicalsThat might somehow get in contact with the chain and guides.
- For any kind of enquiry to our technical department provide the full info according to our Application Questionnaire page 149.



Exceeded pv-limit at chain



Melted flight material

Exceeded pv-limit at curve



Melted curve material



## 3.2 Gripper Chain - Selection guide

LEGEND: ● Low pv | ● High pv | ● Low load | ● High load | ○ Not recommended with respect to wear, noise, corrosion

### Gripper flights

Material	Dry		Dry & Hot		Wet		Wet & Hot		Improved chemical resistance
	Lubricated	No lube	Lubricated	No lube	Lubricated	No lube	Lubricated	No lube	
LFD	●	●			●	●	●	●	
MX	● ●	●	●	●		●			
PP									●
MWX					●	●	●	●	

**MWX** material offers best wear resistance features in dirty environment, e.g. crate washers.

**Standard gripper material:** TPR, for PP-flights grippers are made of EPDM-PP.

**Lubricated means:** friction zones between flights and chain guides are lubricated.

**Hot means:** more than 40° environmental temperature.

**High pv means:** the product of chain pull and speed exceeds 50% of the admissible pv limit\*.

### Roller chains

Material	Dry		Dry & Hot		Wet		Wet & Hot	
	Lubricated	No lube	Lubricated	No lube	Lubricated	No lube	Lubricated	No lube
C45	●	○	●	○	●	○	○	○
NP	●	○	●	○	●	○	●	○
SS	●	○	●	○	●		●	

**Lubricated means:** roller chain is lubricated.

**Hot means:** more than 40° environmental temperature.

**High load means:** the calculated chain pull expectation exceeds 50% of the admis. working load\*.

\* calculate with ChainDim

\* in existing conveyors: measure the temperature of chain and guides - should be below 45°C and check chain flights for residues of melted plastic material.

*Selection guidelines are made on a very general basis. It's important to check every application separately and thoroughly.*

### 3.3 Checklist and protocol for gripper chain conveyor inspection

Check item	Conveyor	Tolerance	YES	NO	Action
<b>Are chain tracks parallel?</b>	Standing still	2 mm			<ul style="list-style-type: none"> <li>• Measure at different points in all conveyor sections.</li> </ul>
Note collected data					
<b>Are gripper ribs oriented correctly/backwards?</b>	Running	-			<ul style="list-style-type: none"> <li>• Make photo/video.</li> </ul>
Note collected data					
<b>Is product accumulation taking place (not allowed)?</b>	Running	-			<ul style="list-style-type: none"> <li>• Make photo/video.</li> </ul>
Note collected data					
<b>Is clamping width between chain tracks adjusted correctly?</b> (just enough to hold the product/can product be pulled off by hand)	Standing still with product	-			<ul style="list-style-type: none"> <li>• Check.</li> </ul>
Note collected data					
<b>Is the chain tension ok?</b>	Standing still	Just no play in the chain			<ul style="list-style-type: none"> <li>• Check mechanical tensioning device.</li> <li>• Read pressure of pneumatic tensioner.</li> <li>• Read type of pneumatic cylinder.</li> <li>• Make photo.</li> </ul>
Note collected data					
<b>Are products touching in curves?</b>	Running	-			<ul style="list-style-type: none"> <li>• Measure the product diameter.</li> <li>• Measure the gap between products in straight and in curve.</li> <li>• Make photo/video.</li> </ul>
Note collected data					
<b>Is the roller chain lubricated?</b>	-	-			<ul style="list-style-type: none"> <li>• Note type of lube system (perma, brushes, manually, etc.).</li> <li>• Note type of lubricant.</li> <li>• Check, if roller chain is actually wet from lubricant.</li> <li>• Make photo/video.</li> </ul>
Note collected data					

### 3.3 Checklist and protocol for gripper chain conveyor inspection

Check item	Conveyor	Tolerance	YES	NO	Action
What's the curve material carry part?	Standing still	-			Material >>
Note collected data					
What's the curve material return part?	Standing still	-			Material >>
Note collected data					
What's the straight chain guide material carry part?	Standing still	-			Material >>
Note collected data					
What's the straight chain guide material return part?	Standing still	-			Material >>
Note collected data					
Do both chain strands run at the same speed (must)?	Running	-			<ul style="list-style-type: none"> <li>• Mark two matching links and check after one revolution of the chain through the entire conveyor, if the links still match.</li> <li>• Make video.</li> </ul>
Note collected data					
Is the gripper version correct (GS1, GS2, GS4)?	-	GS1 soft GS2 solid GS4 small			<ul style="list-style-type: none"> <li>• Are the grippers attaching correctly to the product?</li> <li>• Make video.</li> </ul>
Note collected data					
Are grippers damaged?	Running	-			<ul style="list-style-type: none"> <li>• Make photo/video.</li> </ul>
Note collected data					
Are grippers worn?	Standing still	Elasticity must be enough to hold the product safely.			<ul style="list-style-type: none"> <li>• Measure the gripper height.</li> <li>• Make photo.</li> </ul>
Note collected data					

### 3.3 Checklist and protocol for gripper chain conveyor inspection

Check item	Conveyor	Tolerance	YES	NO	Action
<b>Are flights damaged?</b>	Standing still	-			<ul style="list-style-type: none"> <li>• Make photo.</li> </ul>
Note collected data					
<b>Is the flight plate worn?</b>	Standing still	> 2 mm remaining plate thickness.			<ul style="list-style-type: none"> <li>• Measure plate thickness.</li> <li>• Make photo.</li> </ul>
Note collected data					
<b>Are the TABs worn?</b>	Standing still	Roller chain pins must not look out of the TAB bores.			<ul style="list-style-type: none"> <li>• Check with hair lineal.</li> <li>• Make photos.</li> </ul>
Note collected data					
<b>Are gripper attaching pins looking out of the gripper?</b>	Running	-			<ul style="list-style-type: none"> <li>• Make photo/video.</li> </ul>
Note collected data					
<b>Is the conveyor clean?</b>	Standing still	-			<ul style="list-style-type: none"> <li>• Note describe the dirt/debris.</li> <li>• Make photos.</li> </ul>
Note collected data					
<b>Is the chain running free through the guides?</b>	Standing still	-			<ul style="list-style-type: none"> <li>• Pull the chain manually through the conveyor.</li> </ul>
Note collected data					
<b>Is there noise from collisions?</b>	Running	-			<ul style="list-style-type: none"> <li>• Make video.</li> </ul>
Note collected data					
<b>Is there noise from hard sliding?</b>	Running	-			<ul style="list-style-type: none"> <li>• Make video.</li> </ul>
Note collected data					

### 3.3 Checklist and protocol for gripper chain conveyor inspection

Check item	Conveyor	Tolerance	YES	NO	Action
Is there squeaking?	Running	-			• Make video.
Note collected data					
Are curves worn?	Standing still	3 mm inner chain edge to inner curve edge.			• Make photos.
Note collected data					
Is the roller chain stretched?	Standing still	Stretch limit 19,6 mm/pitch.			• Measure with gauge.
Note collected data					
<b>what's the power consumption of the drive?</b> 1 Dedicated drive for each chain track 1 Central drive for both chain tracks	Running	-			• Read from PLC or measure Amps. << Mark, which drive setup it is << Mark, which drive setup it is
Note collected data (Watt)		(Amps)			
Has the power consumption increased since the conveyor was put in operation?	-	-			• Ask operators.
Note collected data					
Has the power consumption decreased since the conveyor was put in operation?	-	-			• Ask operators.
Note collected data					
Is the power consumption alternating?	Running	-			• Read from PLC or measure Amps. • Note the minimum, maximum, average.
Note collected data					

### 3.3 Checklist and protocol for gripper chain conveyor inspection

Check item	Conveyor	Tolerance	YES	NO	Action
Are there peaks?	Running	-			<ul style="list-style-type: none"> <li>• Read from PLC or measure Amps.</li> <li>• Note the peaks.</li> <li>• Note the frequency of the peaks when and how often they occur.</li> </ul>
Note collected data					
Was there another chain installed before?	-	-			<ul style="list-style-type: none"> <li>• Note type.</li> <li>• Note why it was replaced.</li> <li>• Note any kind of improvement that the customer expects from our chain.</li> <li>• Make photos of old chain.</li> </ul>
Note collected data					
What's the temperature in the friction zone at curve and flights?	Right after switching the conveyor off	< 45°C			<ul style="list-style-type: none"> <li>• Measure with thermometer.</li> <li>• Note the highest value and in which point of the conveyor you found it.</li> </ul>
Note collected data					
Are there cut off chips or metal pieces or other foreign pieces around?	Running	-			<ul style="list-style-type: none"> <li>• Describe.</li> <li>• Make photos.</li> </ul>
Note collected data					
What kind of chemicals come in touch with the chain?	-	-			<ul style="list-style-type: none"> <li>• List all chemicals (cleaning, process, also carried over chemicals from previous production steps, also chemicals for floor cleaning, etc.).</li> </ul>
Note collected data					

**ZERO  
CONTACT**

***Movex***



# ZERO CONTACT

4.1	General maintenance .....	98
4.2	Sprocket selection .....	99
4.3	Support guide and return way .....	100
4.4	Inside rail and frame rail .....	100
4.5	Catenary and belt tension .....	101
4.6	Shaft bearings .....	102
4.7	Belt speed .....	102
4.8	Main components maintenance .....	103
4.9	Disassembling & assembling mode .....	104
4.10	Micropitch conveyor .....	105
4.11	Spare parts .....	106
4.12	Do's and don'ts .....	107

### Before performing maintenance work:

- 1) Keep the work area clean at all times.
- 2) Keep the workbench clean and tidy.
- 3) Keep the work area safe.
- 4) Also be sure to carefully read all the manuals included in the package.

### Important points of attention are:

#### Bearings units:

- All bearings units are hermetically sealed and lubricated for life.
- The flange bearings may be supplied with a grease nipple or lubricated for life.
- Flange bearings with a grease nipple must be lubricated when the bearings do not run freely or replaced when there are signs of wear.
- If “Long Life” bearings are installed and show visible wear, they have to be replaced.

#### Belt:

- For the initial start-up of this conveyor we suggest running it slowly to allow a complete check of the running belt.
- Assure to not have points of obstruction.
- Depending on the application, we recommend checking the belt at least every 2 months or more frequently if required.
- If the wear of the belt is clearly visible it must be replaced.
- After every 1.000 hours, the belt has to be checked to see if stretching is clearly visible, we recommend to remove one or more rows of modules if necessary.

#### Gearmotor:

- For basic maintenance consult the supplier’s manual of the gearmotor, or contact our application engineering department.

#### Cleaning:

- For better conveyor efficiency, cleanliness is necessary to keep it as clean as possible.
- Normal cleaning with warm water is sufficient excessive build up requires a non-aggressive detergent and flush sufficiently afterwards with clean water.
- Take care not to spray the bearings, chain transmission and gearmotors, to avoid the possibility that lubricant is washed away and the danger of an electrical short circuit (Micropitch version).

#### Sprockets and wear strip:

- When the teeth of the sprockets show wear, they should be replaced.
- Wear strip must be replaced when wear is clearly visible and it is recommended to replace when fitting a new belt.

## **Attention!**

- Only allow skilled personnel who are familiar with the applicable regulations and manual to perform work on the conveyor.
- Make sure the conveyor is completely switched off before you begin work on the conveyor.
- Make sure that others cannot activate the conveyor or the installation it is part of.
- You can accomplish this by placing padlocks on the isolating switches or by removing the fuses and placing a warning sign.
- To the extent possible, leave the safety provisions intact during the work activities.

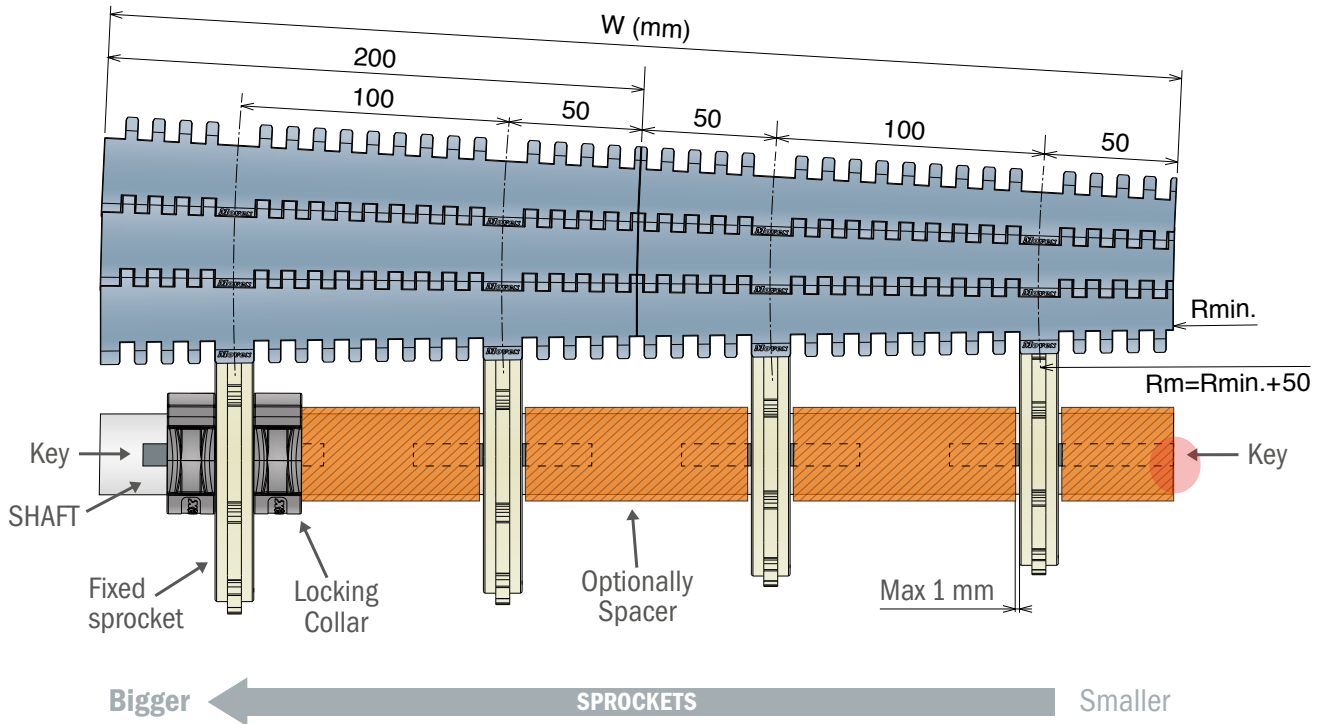

**How to select the sprocket?**

- Based on the belt width and R min.
- One sprocket every 100 mm of belt width: starting from R min. + 50 mm
- Width 200 mm = 2 Sprockets per shaft Width 600 mm = 6 Sprockets per shaft - etc...

**Example: R min. 800 mm / Belt W. 600 mm**

Smaller	<b>Rm 1st sprocket &gt;&gt;&gt;&gt; CODE 162403</b>
↓	<b>Rm 2nd sprocket &gt;&gt;&gt;&gt; CODE 162404</b>
↓	<b>Rm 3th sprocket &gt;&gt;&gt;&gt; CODE 162405</b>
↓	<b>Rm 4th sprocket &gt;&gt;&gt;&gt; CODE 162406</b>
↓	<b>Rm 5th sprocket &gt;&gt;&gt;&gt; CODE 162407</b>
Bigger	<b>Rm 6th sprocket &gt;&gt;&gt;&gt; CODE 162408</b>

*All the sprockets have to be applied with the key way. Axial fixation of sprockets with locking collars or spacers is necessary.*

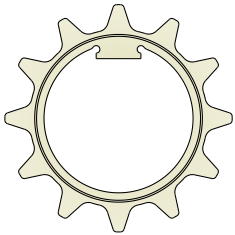

**\* Smallest sprocket with integrated key**  
valid only for code 162401

**NOTE: in order to install the smallest sprockets a shaft key way continued to the end of the shaft is required.**

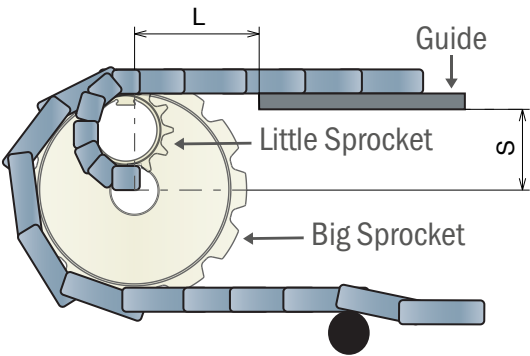

## Zero Contact | 4.3 Support guide and return way

Install the shaft with an angle of 2.5° from horizontal structure.

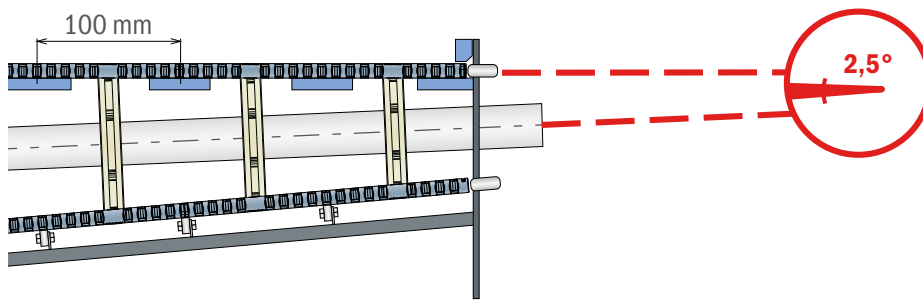

Install the bearings with an angle of 5° from horizontal structure.

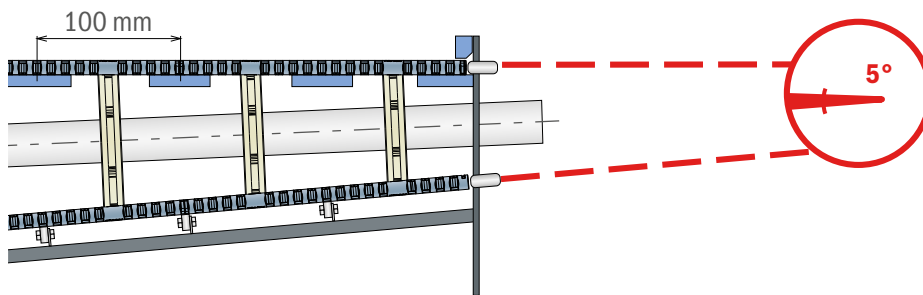

## Zero Contact | 4.4 Inside rail and frame rail

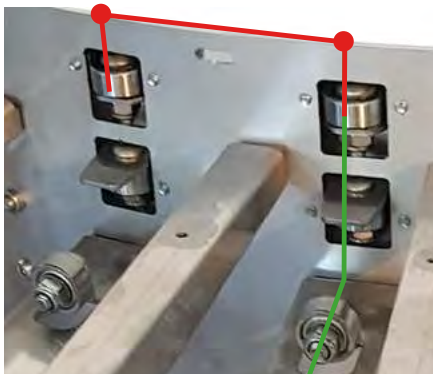

- Max distance between the bearings 200 mm. Five bearings for 90°curve are recommended.
- Belt return rollers/bearings have to be installed at the same position as inside rail bearings.
- Recommendation for the bearings (inside and return support):
  - 12 mm double row 5201-2RS bearing
  - 12 x 18 SST shoulder bolt.

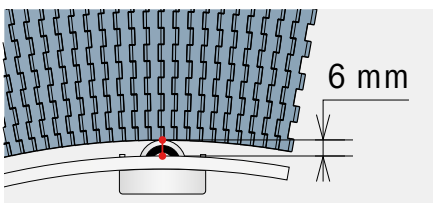

- The inner edge of the belt should never touch the frame. Ensure a minimum gap of 6 mm.

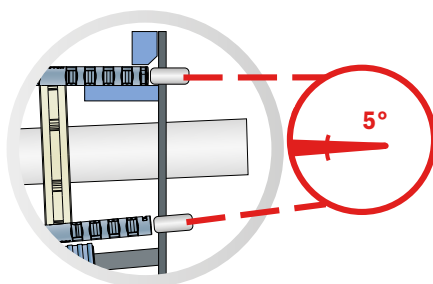

- Caused by the shaft alignment of 2.5° the inside edge of the belt gets closer to the rail frame on the return section than in the carryway.
- All bearing must be placed at an angle of 5°as shown on picture. Ensure the optimum possible contact between belt and bearing.
- Inside edge bearing reduce friction load on the belt, with this solution higher speed is possible.

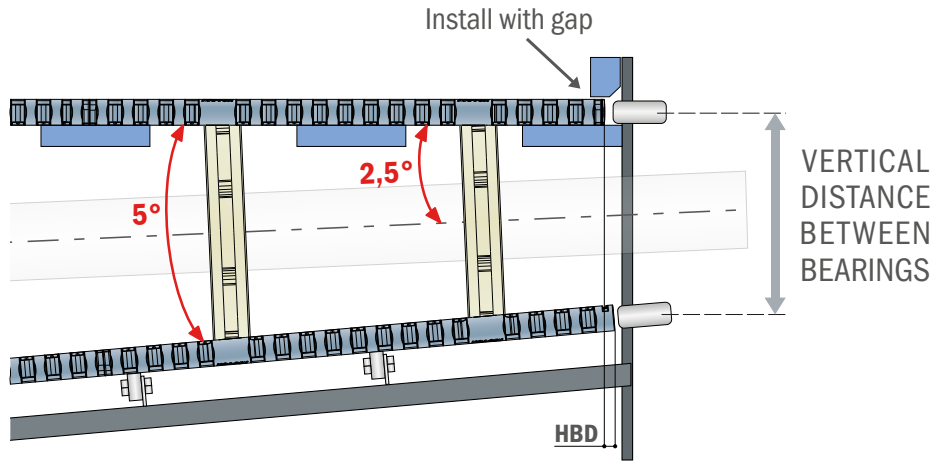

Inside belt radius (mm)	Vertical distance (mm)	HBD Horizontal belt displacement
600	52,5	4,6
800	70,0	6,2
1000	87,5	7,7
1200	105,0	9,2
1400	122,5	10,7
1600	140,0	12,2
1800	157,5	13,7
2000	175,0	15,2



Zero Contact | 4.5 Catenary and belt tension

The modular belt does not require an external tensioning device. Catenary sag will form between return roller shafts.

Periodic check for damage to the modular belt:

- Check the belt (top and bottom sides), gears and wear strips for signs of wear or damage (cuts, grooves, etc.).
- Check the sprockets to ensure they grip the belt properly and that they are in the correct position (diagonally) on the shafts.
- Check the belt return system for worn or damaged rollers.
- Check the rods (remove at least two per section) for wear.
- Investigate the cause of any wear that occurs sooner than normal and plan time as soon as possible to readjust the belt or to take other corrective measures.

## Zero Contact | 4.6 Shaft bearings

For a longer bearing wear life, it's recommended to install an intermediate plate. Matching the bearing housing dimension with an angle of 2,5°.

This type of insertion guarantee a better alignment between bearing and shaft and provides longer duration.

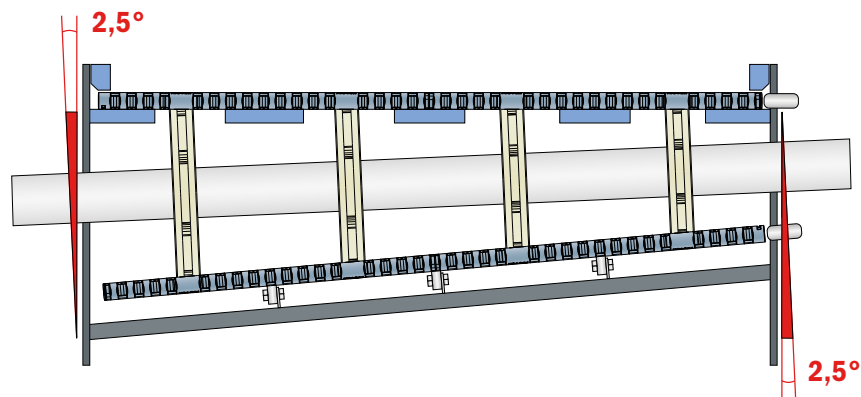

## Zero Contact | 4.7 Belt speed

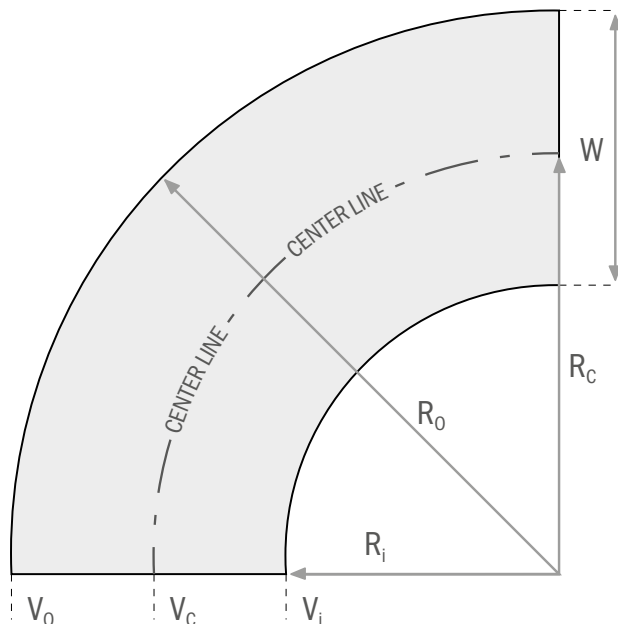

$$V_i = V_c \times \frac{R_i}{R_c}$$

$$= 20 \times \frac{600}{1000}$$

$$= 12 \text{ m/min.}$$

$$R_c = \frac{R_i + R_o}{2}$$

$$R_o = R_i + W$$

$$V_o = V_c \times \frac{R_o}{R_c}$$

$$= 20 \times \frac{1400}{1000}$$

$$= 28 \text{ m/min.}$$

$$V_o = V_c \times \frac{R_o}{R_c}$$

$$V_c = 20 \text{ m/min.}$$

$$V_i = V_c \times \frac{R_i}{R_c}$$

**NOTE:** Set speed of the drive relative to center line of the belt. Consider belt speed inside is less outside higher than center line speed.

### Guide profile replacement

#### Follow these steps:

1. Remove the inside and outside guide profile. At transfer points, tap the profile upwards using a hammer with plastic head.
2. For transfer unit, remove only the upper bolts, loosen the lower bolts a few turns and turn the transfer unit outwards.
3. Divide the modular belt by tapping the connecting pin out of the belt. Use a drift pin. A slot is provided for this purpose in the flanks of the bend. Lay the modular belt open, and pull it out of the bend section.
4. Remove the centre guide profiles.
5. Fit in reverse order.

Note: When connecting the modular belt, use a new connecting pin.

### Sprocket replacement

The sprockets can be easily replaced if the complete drive and return shafts are removed.

Note: The gear reduction motor is not removed. Have a work trolley or similar handy, on which you can place the parts you remove.

#### Follow these steps:

1. Remove the inside and outside guide profile. At transfer points, tap the profile upwards using a hammer with plastic head.
2. For transfer unit, remove only the upper bolts, loosen the lower bolts a few turns and turn the transfer unit outwards.
3. Divide the modular belt by tapping the connecting pin out of the belt. Use a drift pin. A slot is provided for this purpose in the flanks of the bend. Lay the modular belt open, and pull it out of the bend section.
4. Remove the centre guide profiles.
5. Remove the bearing blocks by removing the hex bolt/nut connection (The gear reduction motor is not removed).
6. Remove the entire shaft from the top. > the inside flank has a slot; the outside flank does not.
7. Replace the sprockets (note the order of sprocket size and position of spacers; mark them if desired)
8. Fit in reverse order.

Note: When connecting the modular belt, use a new connecting pin.

### Wear and damage to the modular belt

For the initial start-up of this conveyor we suggest to run it slowly to allow a complete check of the running belt. You must check the modular belt for tension and wear during the first thirty days that the system is operational.

Wear and damage can occur due to the following (this is not an exhaustive list):

- The accumulation of contaminants.
- Belt tension that is too low or high.

After every 1.000 hours, the belt has to be checked to see if stretching is clearly visible, we recommend to remove one or more rows of modules if necessary.

### Disassembling the belt:

- Take the conveyor out of production to ensure it cannot be started during fitting time (isolate electrical supply and use lockers).
- To split the belt it is necessary to remove a cross rod. For conveyors with side guides, a slotted hole is provided in both sides of the frame to make this possible. For conveyors without, or with low side guides, you just lift the belt by hand.
- To take away the locking of the rod remove the plastic clip that is fitted on the outside radius. Use the correct size of blade screw driver [1].
- Remove the rod. This can be done by inserting a small blade screw driver inside the rod's hole passing through the slotted hole, on the inside radius [2]. The rod will come out of the belt [3].
- The belt can now be removed from the conveyor frame.



**Before proceeding to remove the rod, ensure that the belt ends cannot slip away due to its weight.**

### Assembling the belt:

- Lay the belt upside down with the ribs uppermost and slide the belt through the lower part of the frame, to the other end of the conveyor [4].
- Approach one end of the belt to the other in the upper part of the conveyor. Check if the sprockets engage correctly to the belt [5].
- Lay one belt end on the other [6]. If there are modules lying on top of each other, the modules on top should be removed.
- Join the belt ends together by pushing a cross rod in from the outside radius of the belt [7]. Use only original straight rods, bent or deformed rods may affect the performance.
- To block the cross rod inside the belt, with the help of blade screw driver close the external plastic clip. Use the correct size of blade screw driver [8].
- The belt now is correctly assembled.



**Before proceeding to insert the rod, ensure that the belt ends cannot slip away due to its weight.**

NOTE: When connecting the modular belt, use a new connecting pin.





## Zero Contact | 4.10 Micropitch conveyor

Also we have an optional application including the Zero Contact and it is a micropitch conveyor, one understands already from the name that the 8 mm pitch is very small.

This type of conveyor is particularly suitable for product transfers of small and delicate products.

Coupling with Zero Contact saves space or money avoiding more gearmotors for the conveyors infeed or outfeed.

This is possible through chain transmission.

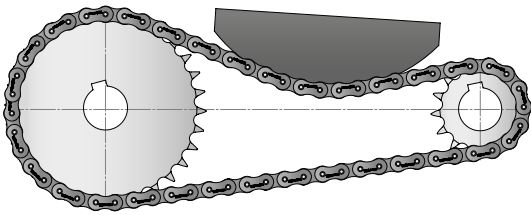
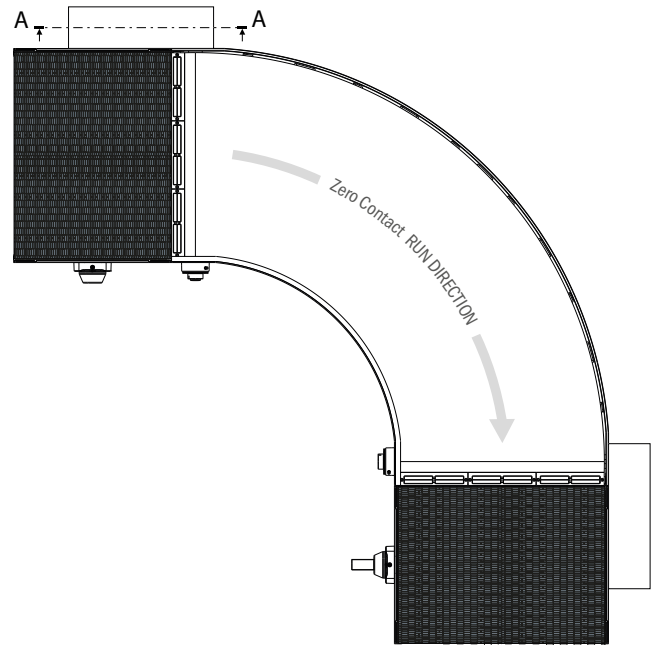

A-A

The belt design enables a smooth and tight transfer, improved tracking, and product stability while allowing a minimum gap between conveyors and prevents products from being damaged and misorientated.

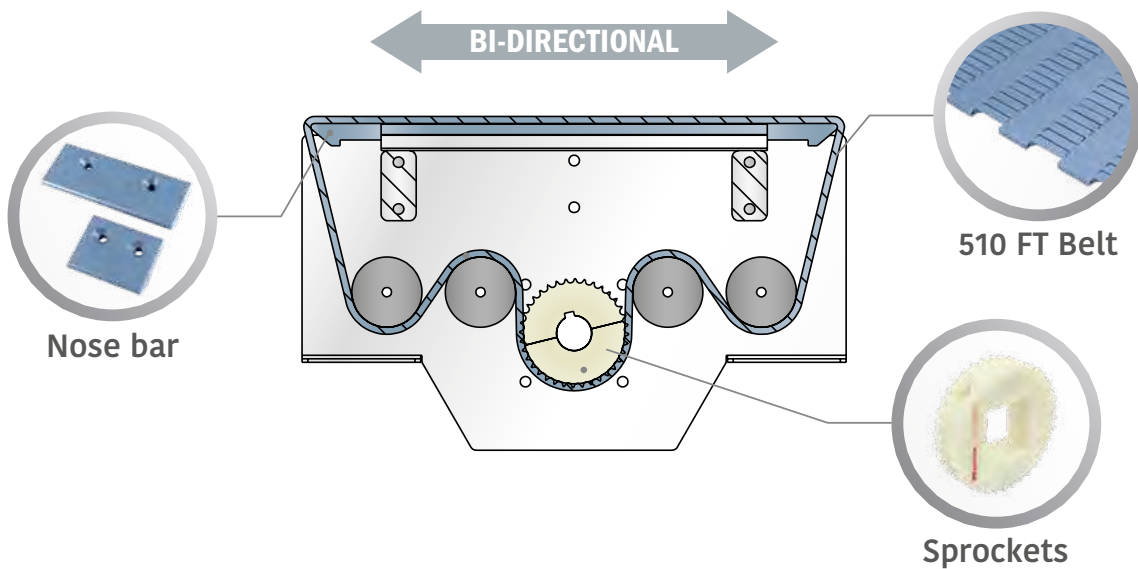

### 510 FT - Belt Technical specifications

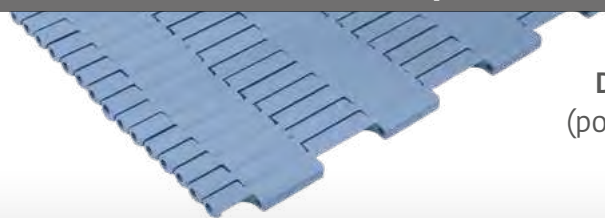

**Drive method**  
(positive driven)

**Belt Material:** LFA

**Weight:** 5,8 kg/m<sup>2</sup>

**Max working load:** 3000 N/m

**Temp. range (dry):** -40÷120°C

**Temp. range (wet):** -40÷60°C

**Max belt speed:** 50 m/min

**Sprockets material:** Polyamide / **Frame material:** Stainless steel  
Nose radius: R3

e.g. Zero Contact  
90 ° Width 800  
Radius 600 Left

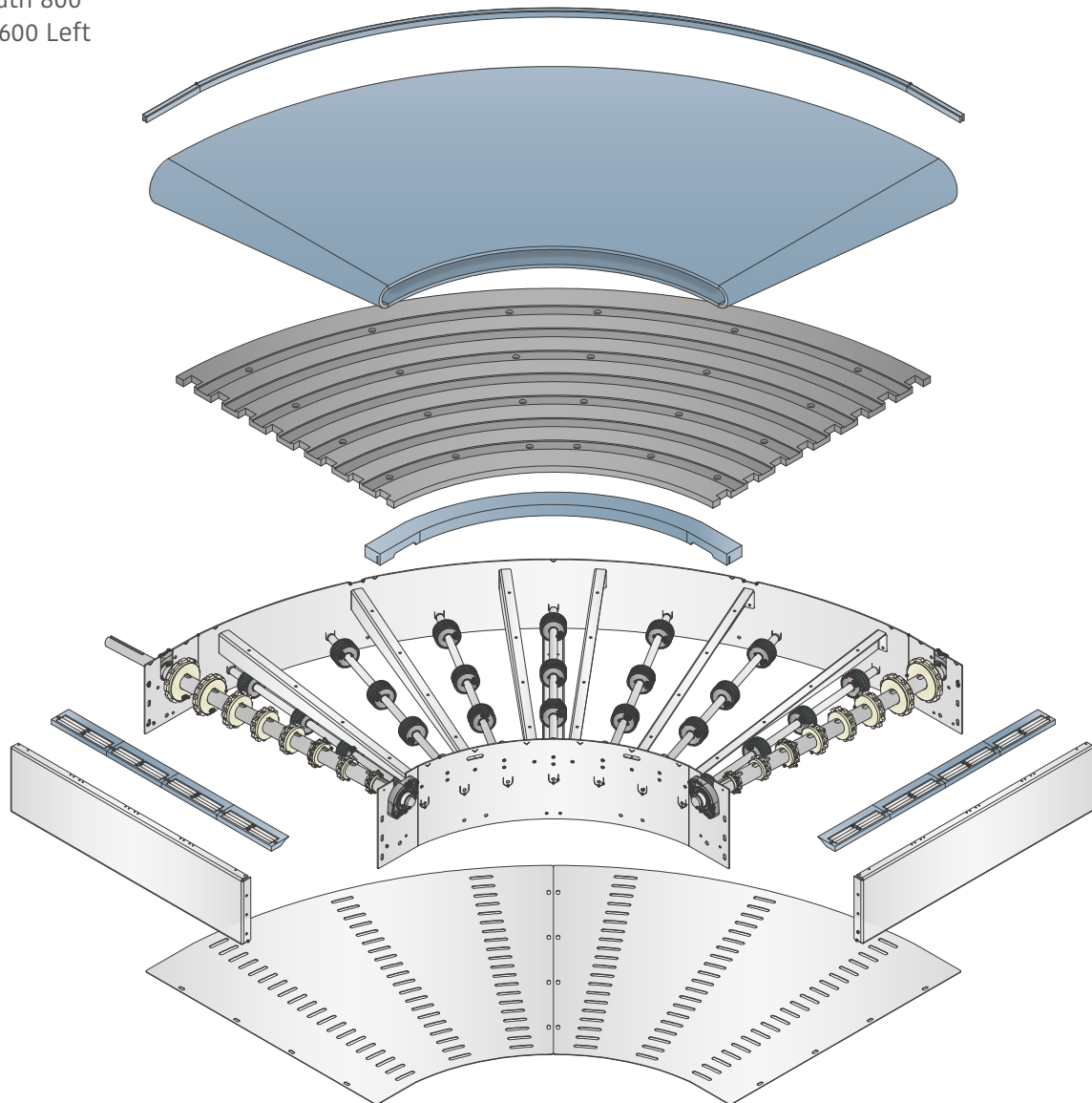

### Description:

Zero Contact™ modular belt W800 R600 90°  
 Machined UHMW-PE sliding curve W800 R600 90°  
 Machined sprocket series Zero Contact™ Z-12 df-40  
 Locking collar with key-seat d-65 df-40  
 Return roller with rubber d-67 b-20 L=41mm grey with blue rubber  
 Locking collar d-40 df-20  
 2-holes solid bearing support watertight UCFL 206/90ECC d 30 OPEN  
 2-holes solid bearing support watertight UCFL 206/90ECC d 30 CLOSED  
 Transfer module with bearing rollers L200mm  
 Zero Contact™ internal profile R600 90° material BluLub  
 Bar cap external profile 19 x 16 material BluLub  
 Lateral side stainless steel safety cover  
 Bottom side stainless steel safety cover  
 Roller bearing  
 Plastic spacer for drive shaft  
 SEW gearmotor type WA30 DRN71M4 food grade oil 0,37 kW

### Quantity

1 piece  
 1 piece  
 16 pieces  
 4 pieces  
 28 pieces  
 56 pieces  
 1 piece  
 3 pieces  
 8 pieces  
 1 piece  
 1,5 m  
 2 pieces  
 1 piece  
 10 pieces  
 14 pieces  
 1 piece

For more details on Zero Contact™ Spare parts consult our dedicated catalog.

	 Assure that the conveyor is properly fixed before starting.	 Be sure the conveyor is correctly levelled before starting-up.
	 Respect the technical specifications.	 Do not overload the belt.
	 Assure proper fitting of all rods before starting the system (especially after first installation & maintenance of the belt).	 Do not operate the system when rods are not properly in place.
	 We suggest starting the belt slowly to check the correct operation and to avoid the stumbling points.	 Do not start the conveyor before checking critical point 's of operation.
	 We suggest to use only warm water for compatible cleaning solutions or cleaning the belt.	 Do not use strong chemicals such as chlorides, acids, etc for cleaning the belt.
	 Pay attention to the conditions of the modular belt.	 Do not operate when the belt is damaged.
	 Keep the conveyor clean to prevent damage.	 Do not climb on the conveyor.
	 Zero contact conveyor is the ideal for food, and beverage processing industry.	 Do not use the conveyor to transport people or animals.
	 Keep conveyor in temperature range under 60°.	 Do not contact with open flame.

# SIDE-FLEXING BELTS

*for typical and major applications out of the beverage field  
as well as other selected fields.*

***Movex***

# SIDE-FLEXING BELTS

5.1 Side flexing belt overview .....	110
5.2 General recommendation .....	110
5.3 Conveyor layout recommendation .....	111

**556 Series - FT Version**

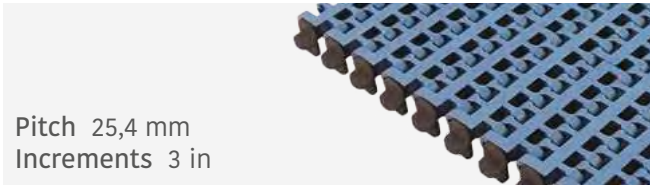

Pitch 25,4 mm  
Increments 3 in

REDUCED TRANSFERS

**600 Series - Standard**

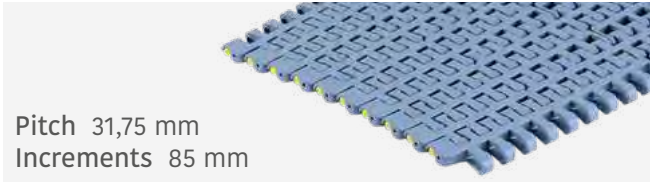

Pitch 31,75 mm  
Increments 85 mm

REDUCED TRANSFERS

**600 Series - Heavy Duty with Bearings**

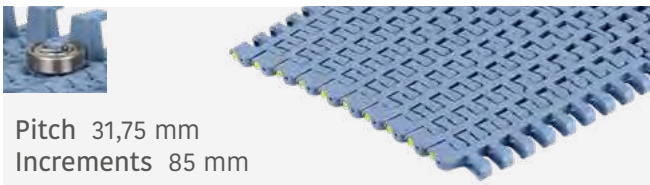

Pitch 31,75 mm  
Increments 85 mm

RUN ON NOSEBAR R. 30 mm | INCREASED STRENGTH  
HIGHER SPEED

**600 Series - Heavy Duty/Small radius**

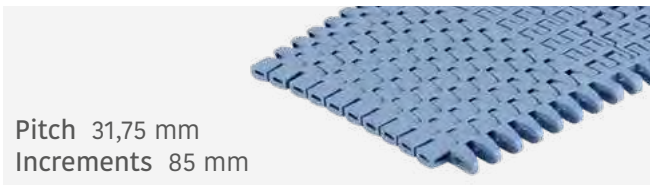

Pitch 31,75 mm  
Increments 85 mm

RUN ON NOSEBAR R. 30 m | SMALLER INTERNAL RADIUS  
INCREASED STRENGTH

**556 Series - GT Version**



Pitch 25,4 mm  
Increments 3 in

REDUCED TRANSFERS | INCREASED GRIP

**600 Series - Heavy Duty**

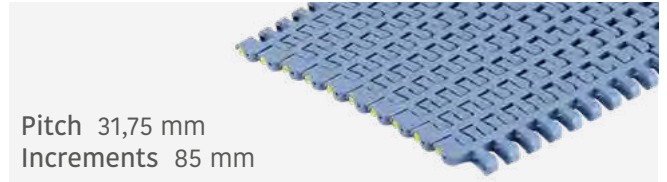

Pitch 31,75 mm  
Increments 85 mm

RUN ON NOSEBAR R. 30 mm | INCREASED STRENGTH

**600 Series - Small Radius**

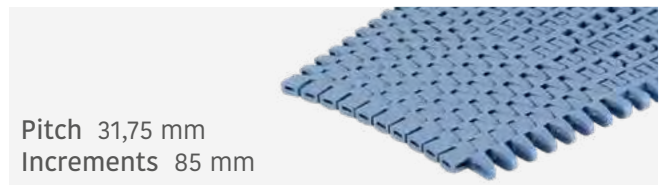

Pitch 31,75 mm  
Increments 85 mm

RUN ON NOSEBAR R. 30 m | SMALLER INTERNAL RADIUS

**600 Series - Heavy Duty/Small radius with Bearings**

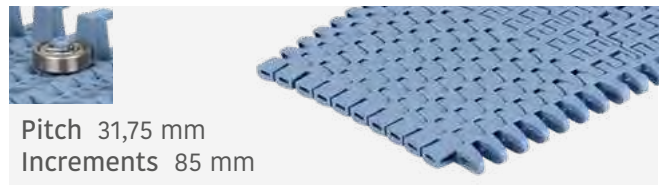

Pitch 31,75 mm  
Increments 85 mm

RUN ON NOSEBAR R. 30 m | SMALLER INTERNAL RADIUS  
INCREASED STRENGTH | HIGHER SPEED

**5.2 General recommendation**

Avoid curves close to drive side (after straight sections): in this case all the weight of carried products will have to be pulled into the curve section, increasing the PV and generating problems.

In case of such a construction, please change the position of the shafts and move the curves closed to idler sides, like the recommended solution.

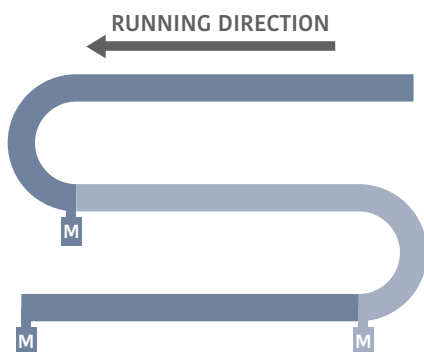

**NOT RECOMMENDED**

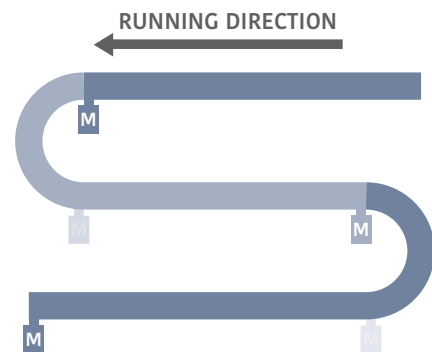

**RECOMMENDED**

## 5.2 General recommendation

In case of 180° curve, try to keep straight section in the middle as shorter as possible, better without them, to guarantee the belt a better and smoother movement.

In case of such straight sections are required, we recommend you to use **BluLub** wear strips and curves and double check with our application engineers.

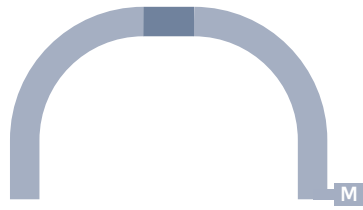

**NOT RECOMMENDED**

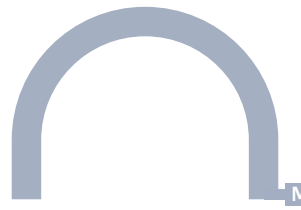

**RECOMMENDED**

Movex machined curves are the ideal choice to guide side-flexing belts in curves.

We always recommend making them with the unique **BluLub**, which offers excel sliding properties and reduced coefficient of friction.

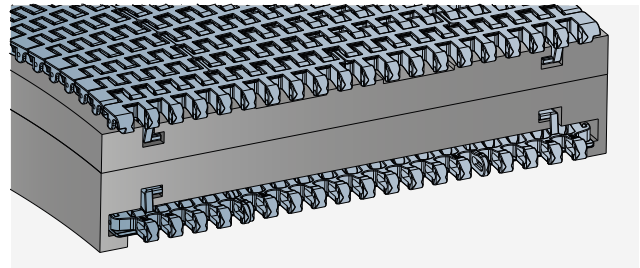

## 5.3 Conveyor layout recommendation

### “S” Shape of the Layout

Only applicable to standard belt version

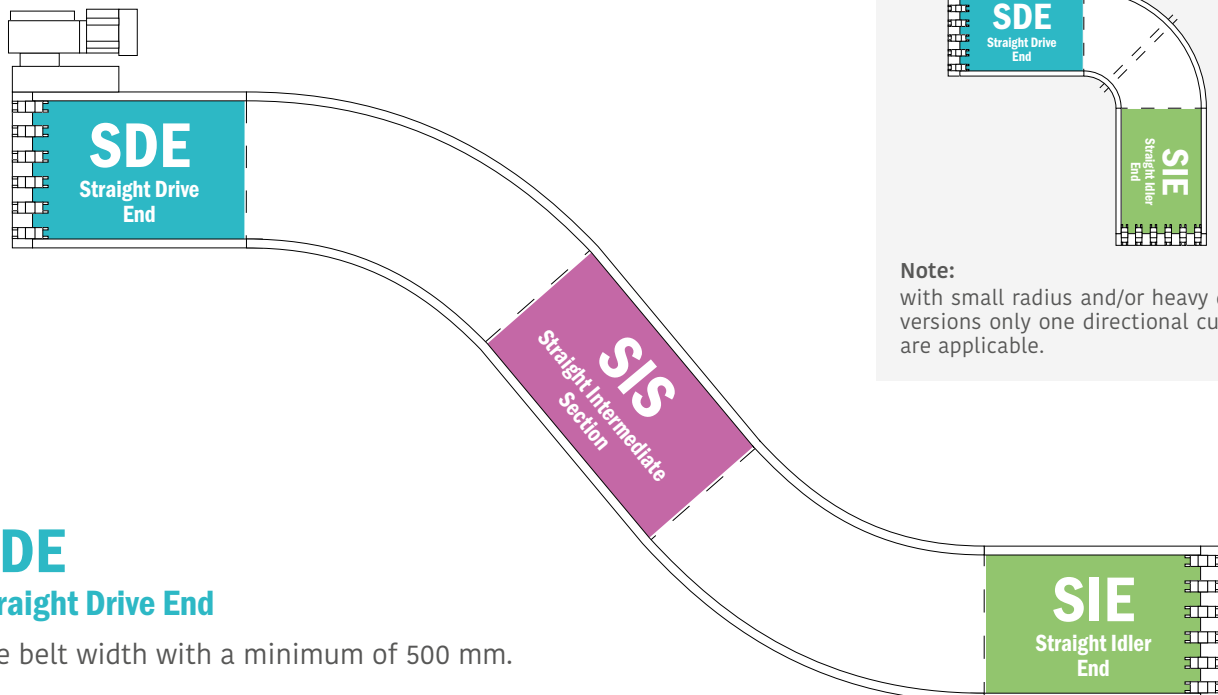

**Note:**

with small radius and/or heavy duty versions only one directional curves are applicable.

### SDE

#### Straight Drive End

The belt width with a minimum of 500 mm.

### SIS

#### Straight Intermediate Section

1.5 times the belt width with a minimum of 500 mm.

### SIE

#### Straight Idler End

The belt width with a minimum of 300 mm.

# MATERIALS

*for typical and major applications out of the beverage field  
as well as other selected fields.*

***Movex***



# MATERIALS

## CHAIN & BELT & COMPONENTS MATERIALS

6.1 Application temperatures .....	114
6.2 Coefficients of friction .....	115
6.3 Heat expansion .....	116
6.4 Water absorption .....	117
6.5 Impact resistance .....	117
6.6 Expansion under tensile load .....	117
6.7 Wear resistance overview .....	118
6.8 PV .....	118

## CHEMICAL RESISTANCE









6.9 Chemical resistance – Table of substances .....	120
6.10 Chemical resistance – PH-range .....	123
6.11 Chemical resistance – General .....	123

## MATERIAL PROPERTIES

6.12 Rubber materials .....	123
6.13 Curve materials .....	124
6.14 Pin materials .....	124
6.15 Static electricity – AS material, black .....	125
6.16 BluLub .....	125
6.17 PFX .....	126
6.18 Steel chains – HB pins .....	127
6.19 Storage of plastic products .....	127
6.20 Note .....	127

## CHAIN, BELT & COMPONENTS MATERIALS | 6.1 Application temperatures

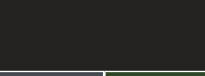
For current scope of supply please refer to the latest Movex catalogue issue. For other materials which are not listed here, ask your Movex contact.

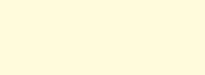
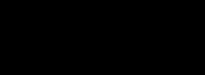
Material	Colour		Chemical abbreviation	Allowable application temperatures range (Celsius)			FDA Approval	EC1935/2004
				Min	Max Dry	Max Wet		
<b>LF/LFA/LFW</b>			POM	-40	80	65	YES	YES
<b>MX/PFX</b>			PBT	-40	120	60	YES	YES
<b>MPX</b>			POM+	-40	80	65	YES	YES
<b>DKM</b>			POM+Aramide	-40	80	65	-	-
<b>MWX</b>			PA	-40	104	-	-	-
<b>PP/PPX</b>			PP	4	80	65	YES	YES
<b>SS</b>	Stainless steel		DIN-EN 1.4016 AISI 430	-30	400	130	-	-
<b>SSE</b>	Stainless steel		DIN-EN 1.4589 AISI S42035	-30	400	130	-	-
<b>SSM</b>	Stainless steel		DIN-EN 1.4589 AISI S42035	-30	400	130	-	-
<b>SSA</b>	Stainless steel		DIN-EN 1.4301 AISI 304	-30	400	130	-	-
<b>PA</b>			PA	-40	105	-	YES	YES
<b>RPA</b>			Reinforced PA	-20	120	120	-	-

**Certificates** for direct contact of food are available on request.

## 6.2 Coefficients of friction

CHAIN/BELT vs PRODUCT | Dry

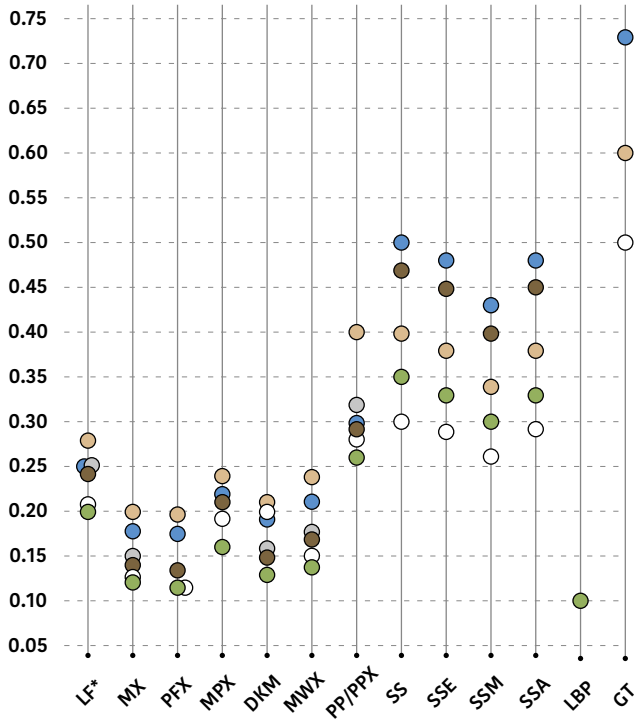

CHAIN/BELT vs PRODUCT | Water

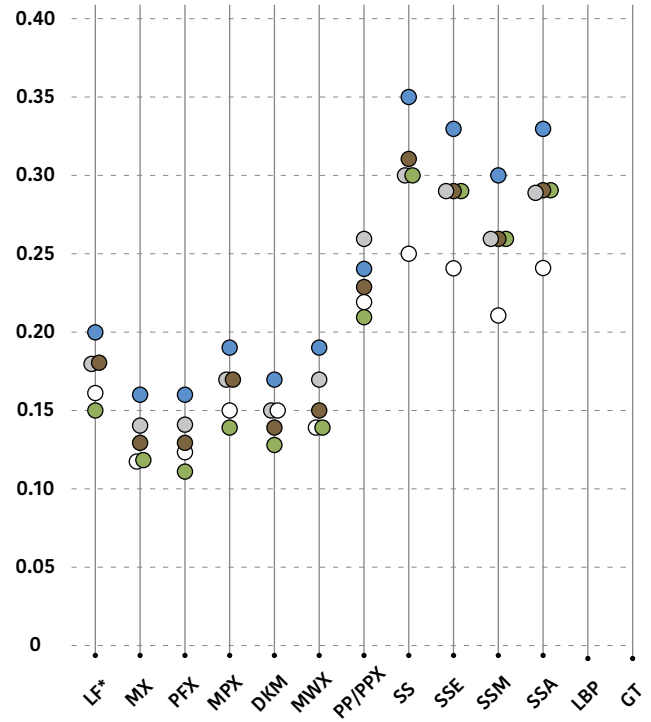

CHAIN/BELT vs PRODUCT | Lubricated

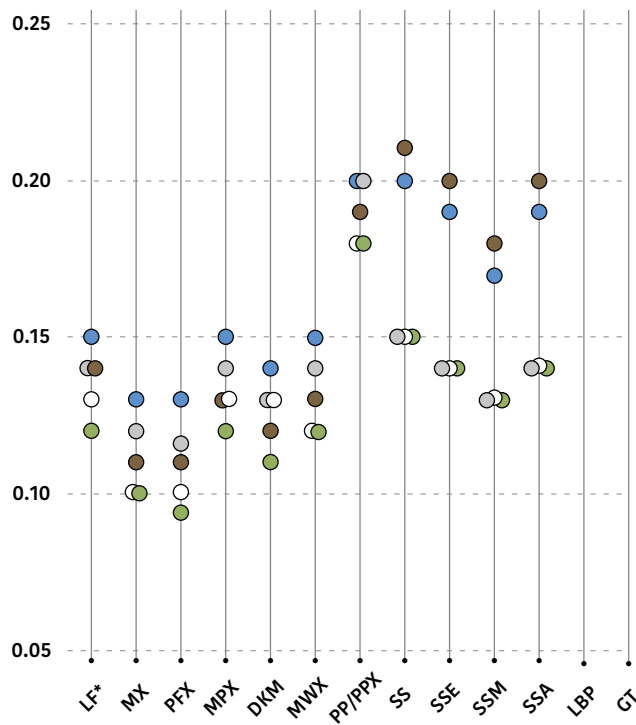

LEGEND:

● Paper/Carton 
 ● Metal (Steel) 
 ● Aluminium 
 ● Plastic (PET) 
 ● Glass (Return) 
 ● Glass (New) 
 \* All colours

## 6.2 Coefficients of friction

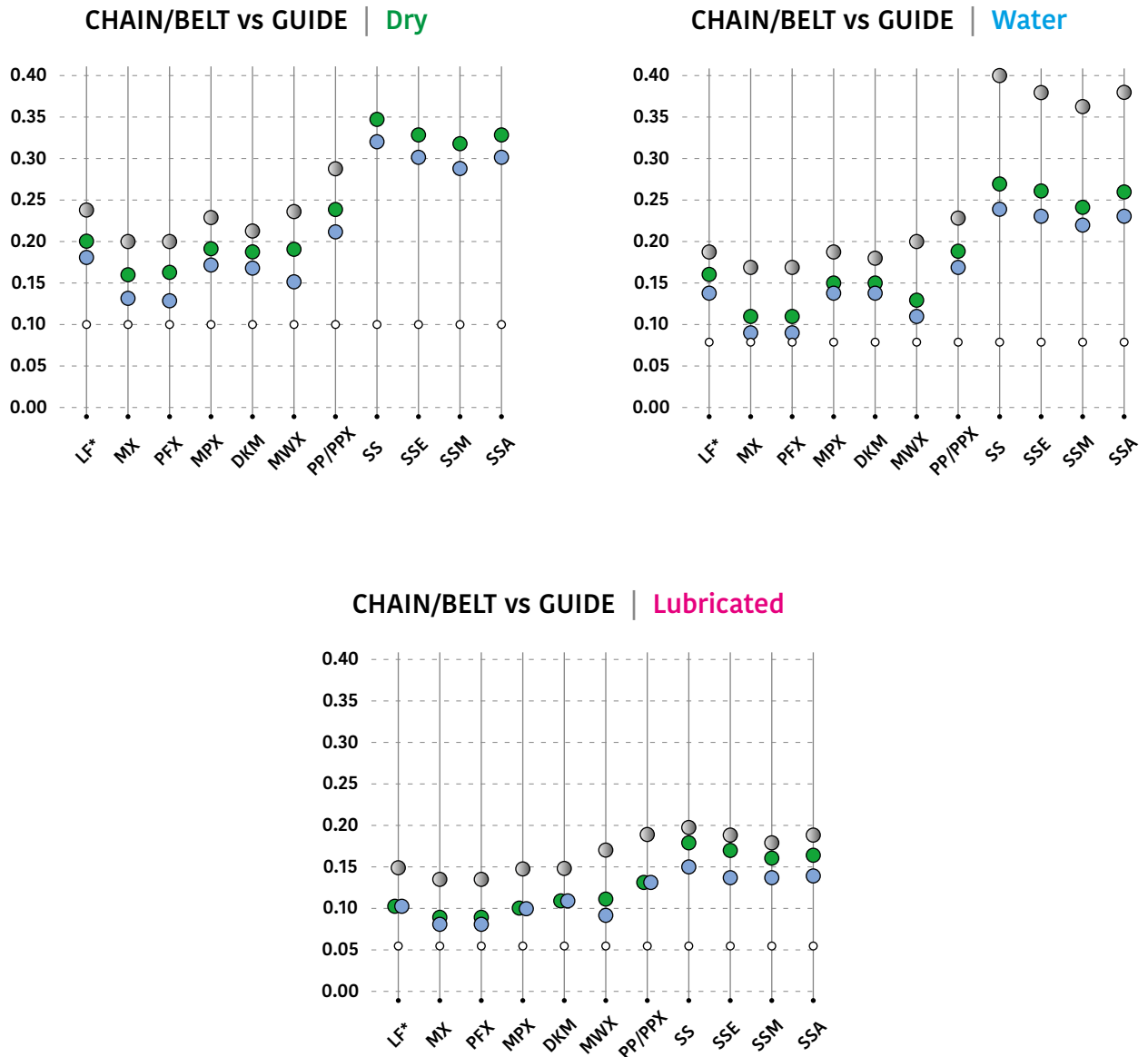

**LEGEND:**

- Stainless steel
- UHMW-PE, PA
- BluLub
- Rollers

## 6.3 Heat Expansion

Calculate expected heat expansion of plastic products according to the formula:

$$\text{Delta length [mm]} = \text{original length [m]} * (\text{actual temperature} - 21)[^{\circ}\text{C}] * \text{heat expansion factor}$$

**Example:** 1020 mm wide belt, LFA (POM) material, belt is heated through in the application to 40°C  
 Delta width: 1,02 m \* (40-21)°C \* 0,11 mm/m/°C = ~ 2,1 mm

Heat expansion factor [mm/m/°C] - approx. values

PBT	POM	PP	UHMW-PE	PE	PA	Stainless steel	Aluminium
0.130	0.110	0.200	0.150	0.180	0.100	0.016	0.023

## 6.4 Water absorption

Immersed in water. Approx percentages.

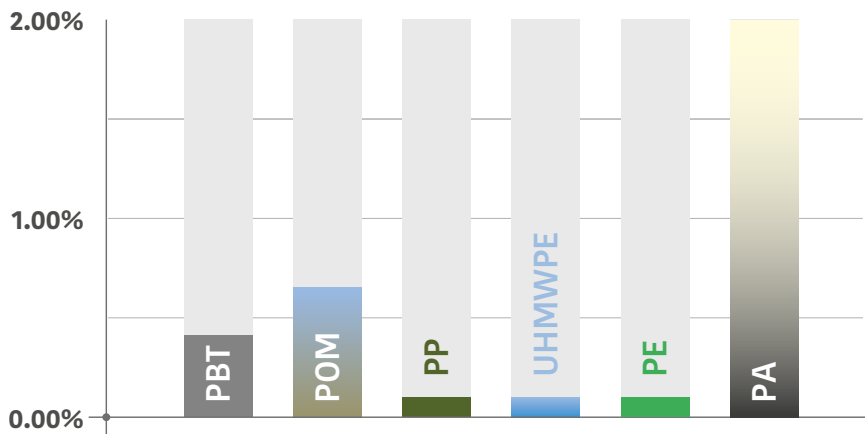

## 6.5 Impact resistance

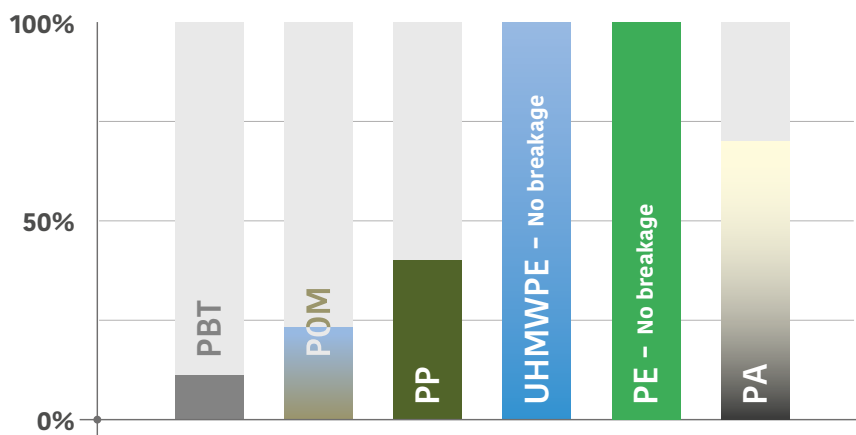

## 6.6 Expansion under tensile load

Tensile creep modulus.

Material plasticity remaining material stretch.

Tensile modulus.

Material elasticity, no remaining stretch.

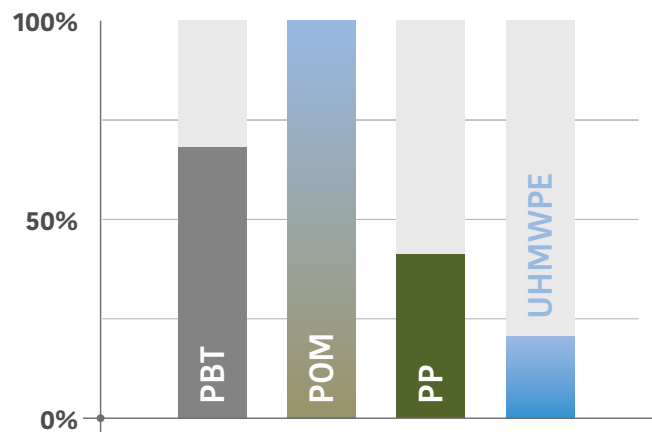
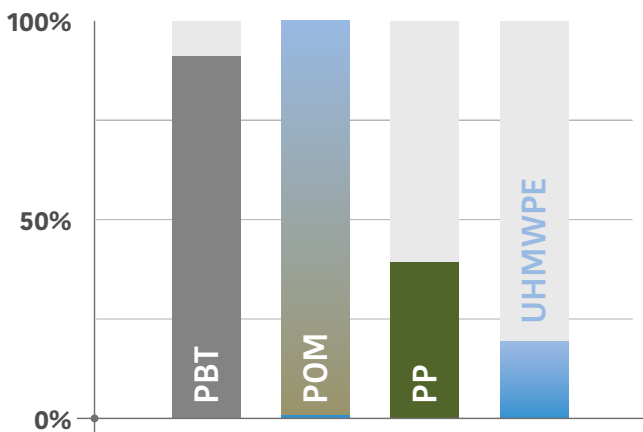

## 6.7 Wear resistance overview

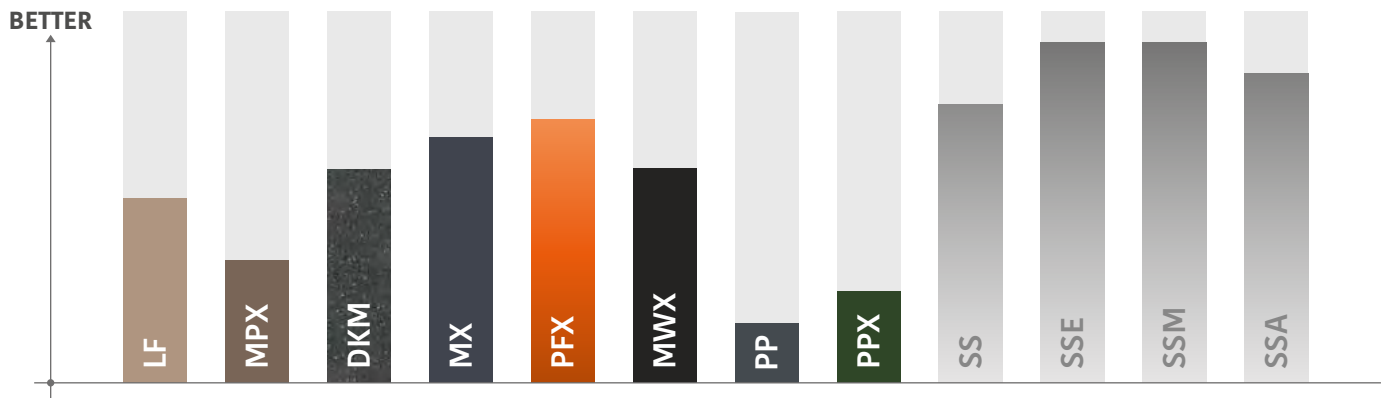

General info applicable to the majority of applications

## 6.8 PV

PV stands for the product of Pressure and Velocity. It can be used as a good indicator for wear resistance and service life expectation for all plastic parts that are subject to relative sliding movement – friction – particularly, if there's no lubrication.

Risk of exceeding PV-limits:

No Risk	Little Risk	High Risk
Low load & Low speed	Low load & High speed	High load & High speed
High load & Low speed		

## 6.8 PV

PV consideration is particularly important for side-flexing conveyors. The graph gives an indication to categorise applications. It is based on an example conveyor with the following layout: Idler – 2m straight – R750 / 90° curve – 4m straight – drive

Without product accumulation/Without lubrication/Clean conditions//Standard conveyor design.

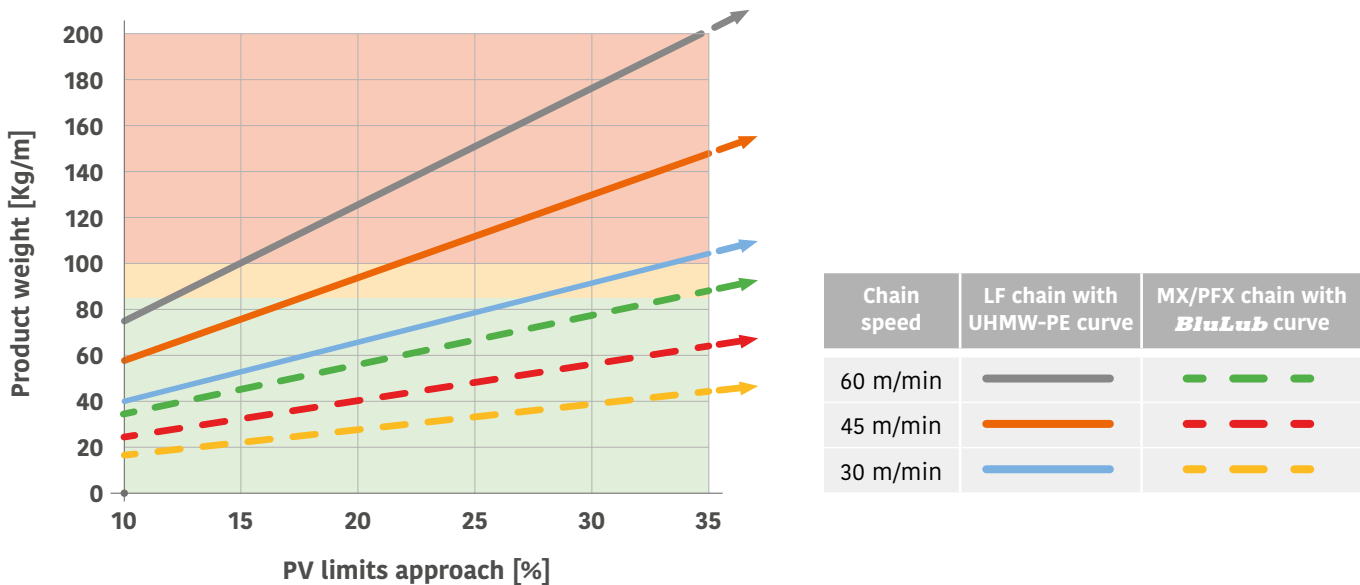

### Exceeded PV-Limit can lead to serious wear life reduction of curve and chain.

PV is not only causing mechanical wear at chains and curves. It's also leading to warming up both components being subject to friction. With plastic materials the mechanical wear resistance is reducing with the temperature. At the same time, friction is increasing with the temperature. Both effects go along with each other and so, an approach or even exceeding of the PV limit (the weaker material sets the limit) can happen. Movex offers materials for chains/belts as well as for curves that reduce friction and at the same time produce less PV (e.g. MX and/or PFX chain/belt material, BluLub chain guide and curve material). Consequently, such materials contribute to dropping risky applications to a lower/safer category. PV calculations are included in the Movex conveyor calculation software, ChainDim.



### If PV problems occur, the following improvement options can be considered:

- Drop friction:
  1. Clean the conveyor and remove any kind of dirt/contamination.
  2. Check the conveyor for obstructions and make sure that the chain is running free.
- Install chain/belt and curve made of higher-grade material:
- Apply lubrication:
  1. In order to keep the conveyor still dry, dry lubrication is an option.
  2. If that's not enough, wet lubrication must be taken into consideration. Wet lubrication also contributes to cooling (water) and cleaning (rinsing effect).
- Shorten the conveyor in order to reduce the chain pull:
  1. Reduce the number of curves in one drive section. One curve per drive is recommended, not more.

## CHEMICAL RESISTANCE | 6.9 Chemical resistance – Table of substances

LEGEND: ● Resistant | ● Conditionally Resistant | ● Not Resistant

Substances	PBT	POM	PP	PE	PA
at norm climate conditions DIN50014, 23°C/50% r.a.h.	Chains & Belts	Chains & Belts	Chains & Belts	Curves Chain guides Components	Sprockets Components Chains & Belts
<b>A</b> Acetamide 50%		●		●	●
Acetic acid, aqueous solution 10%	●	●	●	●	●
Acetic acid, aqueous solution 5%	●	●	●	●	●
Acetic acid, concentrated	●	●	●	●	●
Acetone	●	●	●	●	●
Ammonia, aqueous solution 10%	●	●	●	●	●
Anone			●	●	●
<b>B</b> Benzene	●	●	●	●	●
Benzine	●	●	●	●	●
Bitumen		●	●	●	●
Boric acid, aqueous solution 10%	●	●	●	●	●
Butyl acetate	●	●	●	●	●
<b>C</b> Calcium chloride, aqueous solution 10%	●	●	●	●	●
Carbon tetrachloride	●	●	●	●	●
Chlorobenzene	●	●	●	●	●
Chloroform	●	●	●	●	●
Citric acid, aqueous solution 10%	●	●	●	●	●
Cupric (II) sulphate, 10%		●	●	●	●
Cyclohexane	●	●	●	●	●
Cyclohexanone	●	●	●	●	●
<b>D</b> Diesel oil	●	●	●	●	●
Dimethyl formamide	●	●	●	●	●
Diethyl phthalate	●	●	●	●	●
Dioxane	●	●	●	●	●
<b>E</b> Edible fats, edible oils	●	●	●	●	●
Ethanol 96%	●	●	●	●	●
Ethyl ether	●	●	●	●	●
Ethylacetate	●	●	●	●	●
Ethylene chloride	●	●	●	●	●
<b>F</b> Formaldehyde, aqueous solution 30%		●	●	●	●
Formamide	●	●		●	●
Formic acid, aqueous solution 10%	●	●	●	●	●
Freon, frigen, liquid	●		●	●	●
Fruit juices	●	●	●	●	●
Fuel oil	●	●	●	●	●

Continue >>



## 6.9 Chemical resistance – Table of substances

LEGEND: ● Resistant | ● Conditionally Resistant | ● Not Resistant

Substances		PBT	POM	PP	PE	PA
at norm climate conditions DIN50014, 23°C/50% r.a.h.		Chains & Belts	Chains & Belts	Chains & Belts	Curves Chain guides Components	Sprockets Components Chains & Belts
<b>G</b>	Glycerine	●	●	●	●	●
	Glycol	●	●	●	●	●
	Glycantine, aqueous solution 40%	●	●	●	●	●
<b>H</b>	Heptane, hexane	●	●	●	●	●
	Hydrochloric acid, aqueous solution 2%	●	●	●	●	●
	Hydrochloric acid, aqueous solution 36%	●	●	●	●	●
	Hydrofluoric acid, 40%	●	●	●	●	●
	Hydrogen peroxide, aqueous solution 0.5%	●	●	●	●	●
	Hydrogen peroxide, aqueous solution 30%	●	●	●	●	●
	Hydrogen sulphide	●	●	●	●	●
	Hydrogen sulphide, aqueous solution	●	●	●	●	●
<b>I</b>	Iodine solution, alcohol solution			●	●	●
	Iso-octane			●	●	●
	Isopropanol	●	●	●	●	●
<b>L</b>	Lactic acid, aqueous solution 10%	●	●	●	●	●
	Lactic acid, aqueous solution 90%		●	●	●	●
	Linseed oil	●	●	●	●	●
<b>M</b>	Methanol	●	●	●	●	●
	Methyl ethyl ketone	●	●	●	●	●
	Methylene chloride	●	●	●	●	●
	Milk	●	●	●	●	●
<b>N</b>	Nitric acid, aqueous solution 2%	●	●	●	●	●
	Nitrobenzene	●	●	●	●	●
<b>O</b>	Oxalic acid, aqueous solution 10%	●	●	●	●	●
	Ozone	●	●		●	●
<b>P</b>	Paraffin oil	●	●	●	●	●
	Perchloroethylene	●	●	●	●	●
	Petroleum	●	●	●	●	●
	Phenol, aqueous solution	●	●	●	●	●
	Phosphoric acid, aqueous solution 10%	●	●	●	●	●
	Phosphoric acid, concentrated	●	●	●	●	●
	Potassium dichromate, aqueous solution 10%	●	●	●	●	●
	Potassium lye, aqueous solution 10%	●	●	●	●	●
	Potassium lye, aqueous solution 50%	●	●	●	●	●
	Potassium permanganate, aqueous solution 1%	●	●	●	●	●

Continue >>

## 6.9 Chemical resistance – Table of substances

LEGEND: ● Resistant | ● Conditionally Resistant | ● Not Resistant

Substances	PBT	POM	PP	PE	PA
at norm climate conditions DIN50014, 23°C/50% r.a.h.	Chains & Belts	Chains & Belts	Chains & Belts	Curves Chain guides Components	Sporckets Components Chains & Belts
Propanol	●	●	●	●	●
Pyridine		●	●	●	●
<b>S</b> Salicylc acid	●			●	●
Silicon oils	●	●	●	●	●
Soap solution, aqueous solution	●	●	●	●	●
Soda lye, aqueous solution 5%	●	●	●	●	●
Soda lye, aqueous solution 50%	●	●	●	●	●
Soda solution, aqueous solution 10%	●		●	●	●
Sodium bisulphite, aqueous solution 10%	●	●	●	●	●
Sodium carbonate, aqueous solution 10%	●	●	●	●	●
Sodium chloride, aqueous solution 10%	●	●	●	●	●
Sodium nitrate, aqueous solution 10%	●	●	●	●	●
Sodium thiosulphate, aqueous solution 10%	●	●	●	●	●
Styrene	●	●	●	●	●
Sulphuric acid, aqueous solution 2%	●	●	●	●	●
Sulphuric acid, concentrated 98%	●	●	●	●	●
<b>T</b> Tar	●	●	●		●
Tartaric acid	●	●	●	●	●
Tetrahydrofurane	●	●	●	●	●
Tetralin	●	●		●	●
Toluene	●	●	●	●	●
Transformer oil	●	●	●	●	●
Trichlorethylene	●	●	●	●	●
Triethanolamine	●	●	●	●	●
<b>U</b> Urea, aqueous solution	●	●	●	●	●
<b>V</b> Vaseline	●	●	●	●	●
<b>W</b> Water, cold	●	●	●	●	●
Water, warm	●	●	●	●	●
Wax, molten	●	●	●	●	●
Wine, brandy	●	●	●	●	●
<b>X</b> Xylene	●	●	●	●	●
<b>Z</b> Zinc chloride, aqueous solution 10%	●	●	●	●	●

## 6.10 Chemical resistance - PH-Range

General pH-limits at 23°C	PBT	POM	PP	PE	PA
Lower limit	2	4	1	1	4
Upper limit	9	13	13,5	13,5	12

## 6.11 Chemical resistance – General

LEGEND: ● Resistant | ● Conditionally Resistant | ● Not Resistant

Test condition	PBT	POM	PP	PE	PA
at norm climate conditions DIN50014, 23°C/50% r.a.h.	Chains & Belts	Chains & Belts	Chains & Belts	Curves Chain guides Components	Sprockets Components Chains & Belts
Acids, weak	●	●	●	●	●
Acids, strong	●	●	●	●	●
Alkalines, weak	●	●	●	●	●
Alkalines, strong	●	●	●	●	●
Solvents, alcohol	●	●	●	●	●
Solvents, ester	●	●	●	●	●
Solvents, ether	●	●	●	●	●
Solvents, Ketone	●	●	●	●	●
Water, cold	●	●	●	●	●
Water, hot	●	●	●	●	●

## MATERIAL PROPERTIES | 6.12 Rubber materials

LEGEND: ● Very good | ● Good | ● Worse

Test condition	NBR	EPDM-PP	TPR	TPE
at 23°C	GT stainless steel chains	Gripper chains	Gripper chains	GT plastic chains & belts
<b>Mechanical resistance</b>				
Wear resistance	●	●	●	●
Tear resistance	●	●	●	●
<b>Chemical resistance</b>				
Against acids	●	●	●	●
Against alkalines	●	●	●	●
Against oils	●	●	●	●
Against solvents	●	●	●	●
<b>Application temperatures</b>				
°C -	-30	-40	-50	-50
°C +	100	130	120	120

## 6.13 Curve materials

LEGEND: ● Very good | ● Good | ● Satisfactory

Test condition	UHMWPE	<i>BluLub</i>	C
at 23°C	Extremely high mol. weight	UHMWPE w/built in lubrication	UHMWPE w/ceramic additives
<b>Mechanical resistance</b>			
Wear resistance against steel chains	●	●	●
Wear resistance against plastic chains	●	●	
<b>Chemical resistance</b>			
Against acids	●	●	●
Against alkalines	●	●	●
Against oils	●	●	●
Against solvents	●	●	●
<b>Application temperatures</b>			
°C -	-40	-40	-40
°C + (shortly)	80 (100)	50 (80)	80 (100)

## 6.14 Pin materials

General pH-limits at 23°C	PBT	POM	PP	PE	PA
Lower limit	2	4	1	1	4
Upper limit	9	13	13,5	13,5	12
<b>Stainless steel</b>	<b>Pin</b>		<b>Remarks</b>		
SSM	DIN-EN 1.4057 / AISI 431		Hardened		
SSE	DIN-EN 1.4057 / AISI 431		Hardened		
SS	DIN-EN 1.4057 / AISI 431				
SSA	DIN-EN 1.4301 / AISI 304				
<b>Plastic chains</b>	<b>Pin</b>		<b>Remarks</b>		
<b>All materials</b>	Ferritic Stainless steel (Suitable for magnetic system DIN-EN 1.4016 - AISI 430)		820, 880 TAB (also available with plastic pin POM reinforced)		
<b>Plastic belts</b>	<b>Pin</b>		<b>Remarks</b>		
LFA	PBT		White		
MPX	PBT		White		
DKM	PBT		White		
MWX	PBT		White		
MX/PFX	POM		Grey		
PP	PP		Blue (500 RR: PP grey)		

## 6.15 Static electricity – AS material, black

AS material, Black			
<b>Primary component:</b>	POM	<b>Surface resistivity:</b>	1000 Ohm
<b>Electro conductive component:</b>	Carbon black powder	<b>Chain/belt load capacity:</b>	about 70% of LF
<b>Volume resistivity</b>	5 Ohm m	<i>Consider higher friction than LF as well as less wear resistance than LF.</i>	

## 6.16 BluLub

**BluLub** is a special development of internal lubricated material, specific for applications without lubrication or very limited possibilities to lubricate. By optimizing the process of the production of the material we managed to reach a very homogenous distribution of the solid lubricant which results in more active lubricant in the friction zone.

**BluLub** contains base-material UHMWPE with 9.2m g/mol density in combination with the patented high grade of solid lubricant assuring constantly low friction.

**BluLub** is an ideal material for all kinds of chain/belt guides, e.g. curves and wear strips and for product guides, as well.

Particularly, if friction between product and guide rail has to be reduced, e.g. to improve product handling and/or reduce product damage.

**BluLub** complies with the Code of Federal Regulations of FDA.

### **BluLub**

*is particularly suitable for:*

- Dry running applications
- Less energy consumption
- Reduced noise/squeaking
- Running chains and belts smoothly
- Long wear life
- High speed
- Smooth and save product handling

### **BluLub** VS Standard UHMWPE

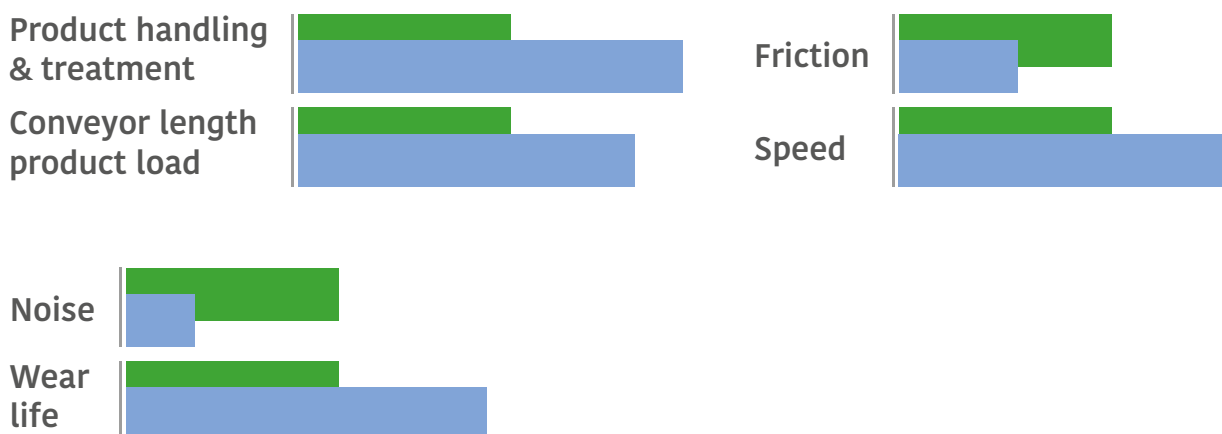

## 6.17 PFX

**PFX** is a plastic compound developed specific for chain and belts in order to run with limited lubrication or in dry applications where the demands are extreme concerning speed, performance & efficiency.

**PFX** is developed to reduce the friction between chain and product as well as chain and wearstrips even if no lubrication is used.

### Friction factors with Wearstrip material

Lubrication	Stainless steel	UHMW-PE & PA	<i>BluLub</i>
Dry	0,18	0,16	0,12
Water	0,15	0,10	0,08
W&S/ Dry lube	0,13	0,08	0,07
oil	0,09	0,09	0,09

### Allowable application temperatures

Temperatures - Fahrenheit / Celsius		
Min.	Max.	
Dry & Wet	Dry	Wet
-40°F/-40°C	248°F /120°C	140°F /60°C

### Friction factors with Product material

Lubrication	Paper & Carton	Metal (steel)	Aluminum	Plastic & PET	Glass (returnable)	Glass (new)
Dry	0,18	0,16	0,14	0,10	0,11	0,10
Water	n.a.	0,14	0,13	0,11	0,12	0,11
W&S/ Dry lube	n.a.	0,12	0,11	0,09	0,10	0,09
oil	n.a.	0,09	n.a.	n.a.	n.a.	n.a.

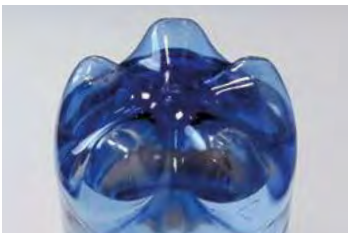

PET Bottle - PFX material

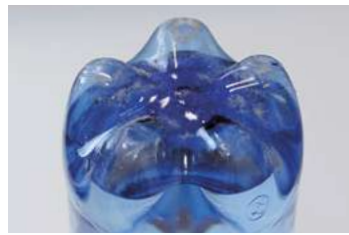

PET Bottle - Standard material

Extra Performance material  
(PBT with additives)

Colour: Fluorescent Orange

Primary Components: PBT

FDA approved.

### PV

RELATIVE TO PFX = 100

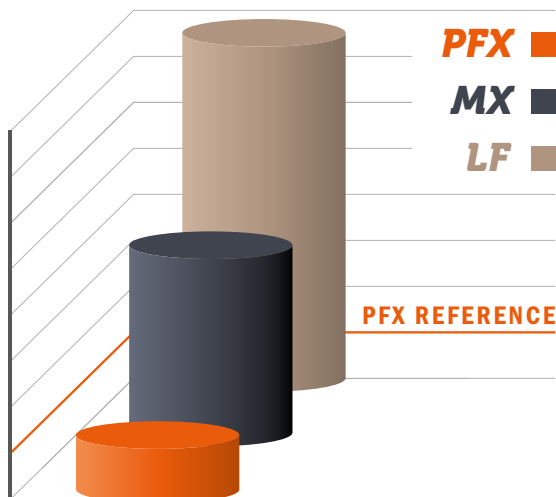

### Power saving

RELATIVE TO LF = 100

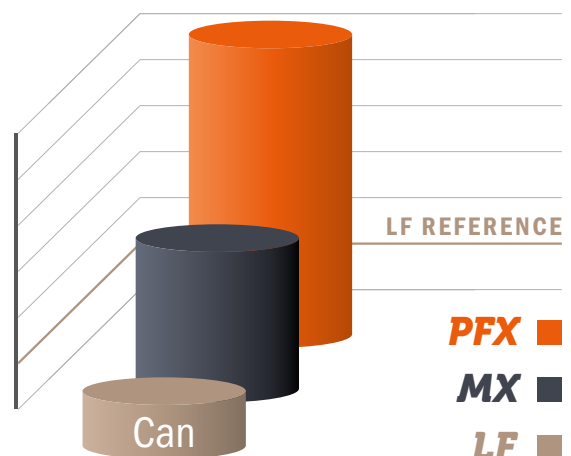

Example calculated with cans UHMWPE chain guides  
90°side-flexing conveyor under accumulation.

## 6.18 Steel chains - HB pins

---

HB pins are recommended for applications with the following characteristics:

- **High load/chain pull and/or high speed**  
Typically present in filler & labeller area of a filling line. HB pins are reducing chain elongation.
- **High requirements for product stability**  
Typically present in in- & outliners. HB pins keep chains flat for a longer operating period, e.g. by keeping the gaps between chain links short.
- **High start/stop frequency of conveyors**  
Typically present in the heart of a filling line. HB pins are able to withstand a much higher number of load peaks which are present when a drive accelerates.
- **High number of load cycles/chain revolutions**  
Typically present in short conveyors that run at high speed. HB pins offer due to their extraordinary hardness an higher wear resistance.
- **Abrasive environmental conditions**  
HB pins are more wear resistant. Chain elongation is caused by approx. 67% by pin wear and only 33% by hinge eye wear. HB pins are through hardened and offer these advantageous features over the entire service life. HB pins are a typical TPM/TCO product. They help reducing down time and increasing line efficiency.
- **Chain service life is about doubled**

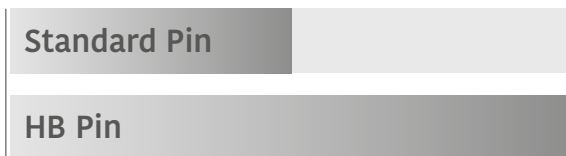

## 6.19 Storage of plastic products

---

1. Store plastic products (chains, belts, components) in their original packaging.
2. Avoid environmental radiation/sun light/UV.
3. Keep dry.
4. Keep free of aggressive substances, avoid chemical attack.
5. Keep a constant environmental temperature between 5 and 35°C.
6. FIFO: just like we do in our warehouse, apply the First In and First Out system in your logistic process, as well.
7. Be aware that plastic material is aging. Keep pallets, stacks of plastic products, free from heavy goods on top. Do not stack higher than shipped originally ex Movex. Plastic materials deform under long-term static load.

## 6.20 Note

---

Movex is continuously developing new materials, optimizing existing materials, customizing materials for specific needs.

In our catalogue we can only show standard materials that are commonly used for the majority of applications.

Contact us for finding a material solution for your specific application.

# CLEANING



# CLEANING

7.1 General .....	130
7.2 Frequency .....	130
7.3 Method .....	131
7.4 Chemical resistance .....	131

Cleaning is necessary to:

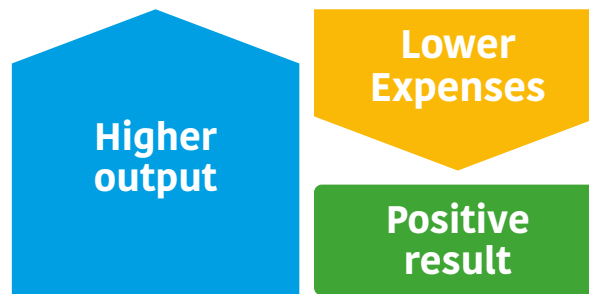

- Minimize dirt and debris build up.
- Keep bacteriological situation under control.
- Elongate service life of chains/belts.
- Ensure smooth running of chain/belt for optimum product stability.
- Keep maintenance expenses low. Less labor as well as less spare parts consumption.
- Prevent malfunction due to sticky residues.
- Keep friction low, keep line efficiency high.
- Prevent crashes due to glass debris, etc.

**Who's involved?** All parties!



### Line manufacturer

- Design easily cleanable conveyors.
- Design layouts that make all conveyors easily accessible.



### Components supplier

- Offer the right parts.
- Give correct instructions.



### Lubrication & cleaning agents supplier

- Offer the right chemicals.
- Give correct instructions.



### End user

- Do correct supervision.
- React quickly, if something goes wrong.
- Install and respect a cleaning regime.

## 7.2 Frequency

### Daily:

- Check conveyors for broken glass and other debris or foreign parts. Remove immediately.
- Check for sticky residues on and in the conveyor that lead to product handling issues. Conduct immediate intermediate cleaning.

### Weekly:

- Check areas where process liquids (e.g. disinfection or internal device cleaning, product leakage) are carried over into the next conveyors. Carried over chemicals can cause chemical attack at plastic chains/belts. Process liquids and product leakage can lead to contamination layer build up and to increased friction. Rinse conveyors immediately.

## 7.3 Method

---

### Inspection:

Important for an optimum service life of the chains and belts as well as conveyor components is a general and permanent inspection of the conveyors during operation.

- Listen for strange rattling or squeaking noises.
- Check transfer plates, return rollers, bearings, etc... make sure the chain/belt is still running free without extra load or obstruction.
- Often the service life of a chain/belt is reduced for mechanical reasons that can be sorted easily.

### Cleaning:

- When cleaning, we advise to go through the following steps:
- Check for foreign parts on the conveyor. Check also the return part. Lift chains to check the chain guides.
- Rinse with warm (max. 60°) or cold water thoroughly.
- Wash with mild (pH 5-9) detergents according to chemicals supplier's instruction.
- Conduct intermediate rinsing between chemical agent changes.
- If necessary clean manually (soft brush) when pollution is hard to remove. Rinse thoroughly with warm (max. 60°) or cold water. Make sure all detergent is rinsed off while chain/belt is running.
- Finally, conduct a mechanical check that chain/belt is running free without obstruction.

### **Important!**

- Clean also inside the conveyor as well as the return part of the conveyor.
- Only use cleaning detergents that are compatible with chain/belt and conveyor components material.
- Respect temperature limits.
- When using high pressure devices, cleaning staff has to be instructed to use them carefully.
- Conveyor components, basically plastic part, can get damaged by too long and too hard pressure cleaning. Also bearings can get damaged by cleaning solutions being pressed into the housing.
- To the extent possible, leave the safety provisions intact during the work activities.

## 7.4 Chemical resistance

---

Find an outline of chemical resistance data in the chapter 6.9 page 120.

Consult your chemicals supplier for compatibility information/recommendation. In case of doubts, contact Movex for a chemical compatibility check.

If you have the chance to conduct a practical application test, do the following:

- Put a piece of chain/belt or conveyor component in a container.
- Fill the container with the chemical solution in the final application concentration.
- Conduct a quick check after 2 hours, 4 hours, 8 hours, 1 day, 2 days, 3 days, 5 days:
  1. Check for color changes, in most cases chemical attack is indicated by decoloring, whitening.
  2. Check for deformation of the immersed part.
  3. Check for cracks, use a magnifying glass.
- Protocol the test and make photos.

**INSPECTION  
GUIDELINES**

# INSPECTION GUIDELINES

8.1 Chain & belt .....	134
8.2 Sprockets & Idlers .....	135
8.3 Return rollers .....	135
8.4 Magnetic curves .....	135
8.5 Wear strip .....	136
8.6 Powder .....	136
8.7 Broken off pieces underneath the conveyor .....	136
8.8 Noise .....	137
8.9 Conveyor .....	138
8.10 Cleanliness .....	139

# INSPECTION GUIDELINES

Checklist for regular, intermediate and preventive conveyor inspection and maintenance including optimization hints.

## 8.1 Chains & Belts

LEGEND: ● Stop conveyor & remove part that's being inspected | ● Check in production mode | ● Check in stand still

### Pitch

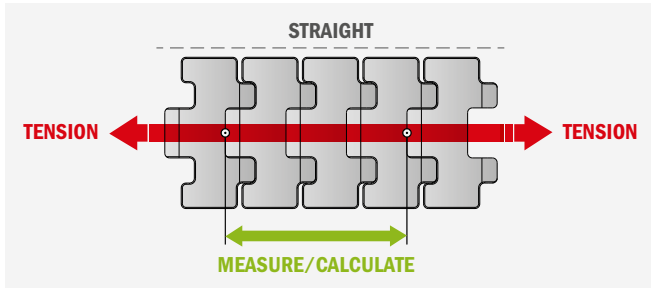

- Measure (general rule: limit = nominal pitch + 3%)
- Observe catenary – should hang about 100 mm deep, if more, this indicates chain/belt elongation.

### Plate thickness

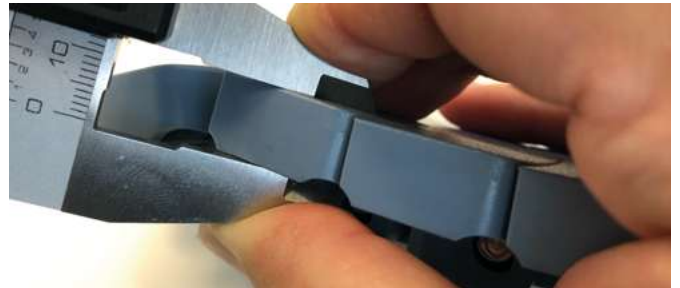

- Measure (general rule: limit = 50% of nominal thickness)

### Product side surface, FT

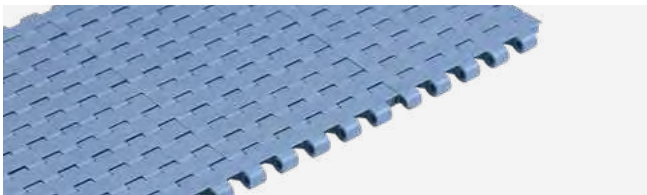

- Observe product flow (product handling/stability)

### GT surface

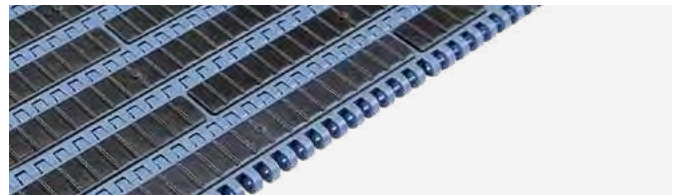

- Check surface (general rule: limit = 50% of rubber surface lost)
- Observe product flow (functionality: e.g. stop, devide)

### FG surface



- Check surface (general rule: limit = 50% of holes blocked)

### LBP surface



- Check surface (general rule: 1 damaged/missing roller per shaft is acceptable)
- Observe product flow (functionality: accumulation)

### Hinges



- Check for damage

### Positioners



- Check for damage

### TABS



- Check for damage

## 8.2 Sprockers & Idlers

LEGEND: ● Stop conveyor & remove part that's being inspected | ● Check in production mode | ● Check in stand still

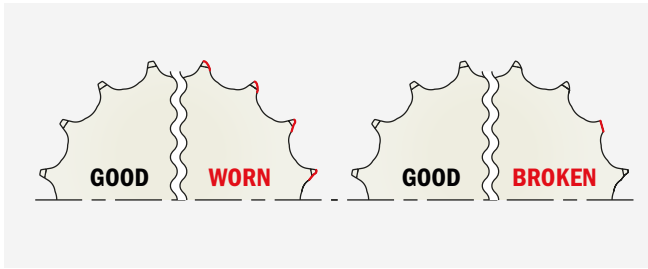

### Teeth

- Check for damage

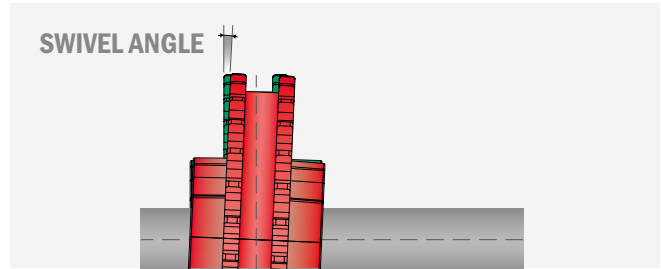

### Play between bore and shaft

- Check swivel angle  
(general rule for loose sprockets: limit = 1 mm play)

### Position

- Check position relative to chain/belt according to product data sheets and Sprocket position page 21.

## 8.3 Return rollers

LEGEND: ● Stop conveyor & remove part that's being inspected | ● Check in production mode | ● Check in stand still

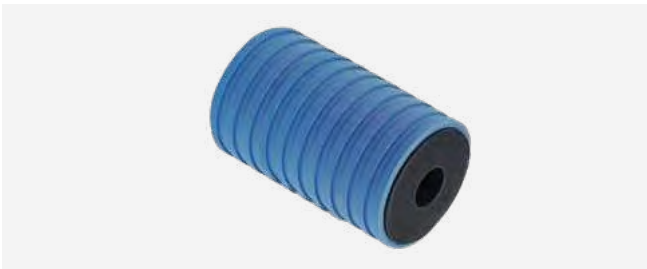

### Surface

- Check for damage, embedded particles.

### Play between bore and shaft

Check play  
(general rule: limit = more than 3 mm play).

### Free rotation

- Observe free rotation.

### Position

- Observe correct and fix position relative to chain/belt.

## 8.4 Magnetic curves

LEGEND: ● Stop conveyor & remove part that's being inspected | ● Check in production mode | ● Check in stand still

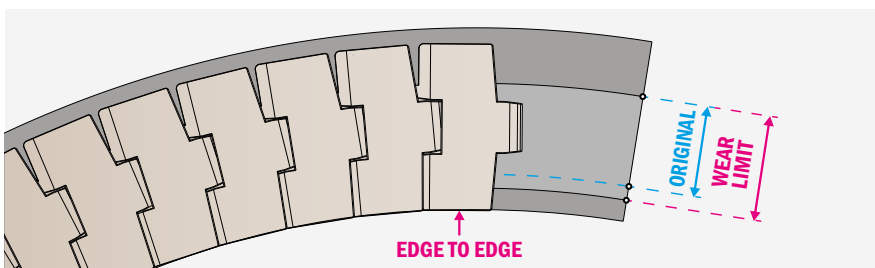

### Curve track / groove

- Check for wear at sliding side of the groove  
(general rule: limit = if the edge of the chain at the inner side of the curve is approaching the edge of the curve).

## 8.5 Wear strip

LEGEND: ● Stop conveyor & remove part that's being inspected | ● Check in production mode | ● Check in stand still

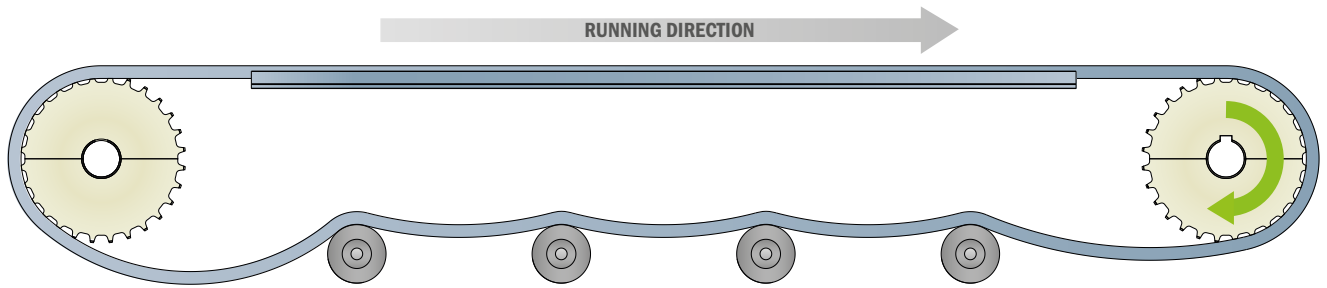

### Surface

- Check for damage, embedded particles.
- Measure thickness.  
(general rule: 0,5 mm reduction is acceptable, 0,2 mm reduction in sensitive sections, e.g. inliners)

### Position/alignment

- Check for straightness.
- Check for smooth and well aligned connections.
- Measure track pitch – chains/belts must run free.

### Ends

- Check for correct chamfering.
- Check for correct distance of wear strips to shaft centre. (general rule: 1 pitch)

## 8.6 Powder

LEGEND: ● Stop conveyor & remove part that's being inspected | ● Check in production mode | ● Check in stand still



### Interaction between chain/belt and wear strips and curves

- Observe – powder residues at connections between wear strips as well as wear strips and curves indicate that a re-adjustment is required.



### Interaction between product and product guides

- Observe – powder residues at product guides indicate that abrasive conditions have arrived and cleaning is required, respectively replacement of product guides.

## 8.7 Broken off pieces underneath the conveyor

LEGEND: ● Stop conveyor & remove part that's being inspected | ● Check in production mode | ● Check in stand still

### In any position

- Observe – find collision points between conveyor construction and chain/belt.
- Check for foreign parts that got stuck somewhere in the conveyor.
- If the source cannot be identified, move a piece of chain/belt manually through the conveyor and feel where it's catching.



## 8.8 Noise

LEGEND: ● Stop conveyor & remove part that's being inspected | ● Check in production mode | ● Check in stand still

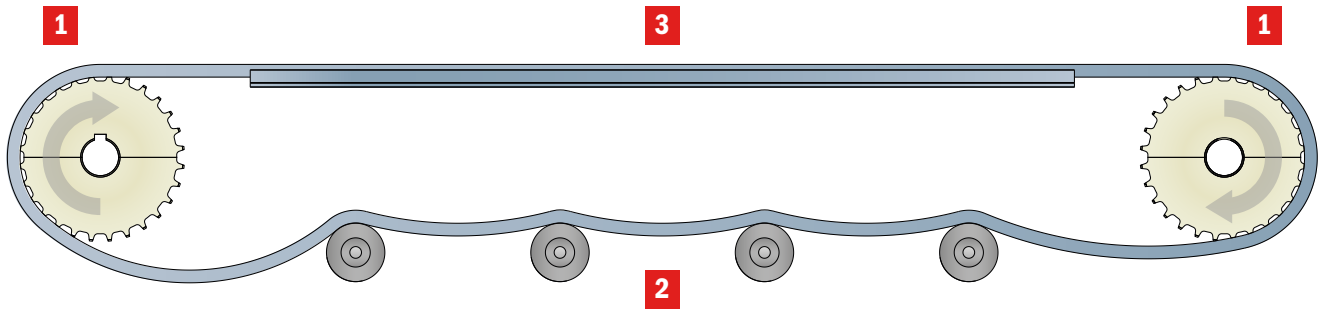

### Interaction between chain/belt and sprocket/idler [1]

Listen – extraordinary noise in that position indicates:

- Wrong position of sprockets.
- Elongated chain/belt causing jumping.
- Chain/belt not releasing properly from the sprocket e.g. caused by sticky circumstances or short catenary.
- Misaligned wear strips.
- Damaged sprocket teeth.

### Interaction between chain/belt and return rollers [2]

Listen – extraordinary noise in that position indicates:

- Damaged return rollers.
- Non-rotating return rollers.

### Interaction between chain/belt and wear strips [3]

Listen - extraordinary noise in that position indicates:

- Damaged or misaligned wear strips.
- Incorrect ends of wear strips.
- Misaligned connections.

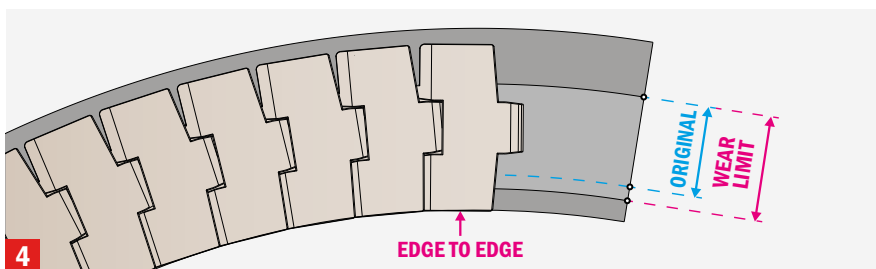

### Interaction between chain/belt and curve [4]

Listen - extraordinary noise in that position indicates:

- Incorrect connection between curve and wear strips.
- Too much wear at sliding surface of the curve.
- Exceeded pv-limit.
- Too much wear at chain/belt hinges causing protruding/scratching pins.

## 8.9 Conveyor

LEGEND: ● Stop conveyor & remove part that's being inspected | ● Check in production mode | ● Check in stand still

### Wrap around angle – chain/belt around drive sprocket

- Observe – general recommendation:  $140^{\circ} \pm 10^{\circ}$   
More can cause problems with chain/belt release from the sprocket, less can cause problems with torque transmission respectively jumping chain/belt.

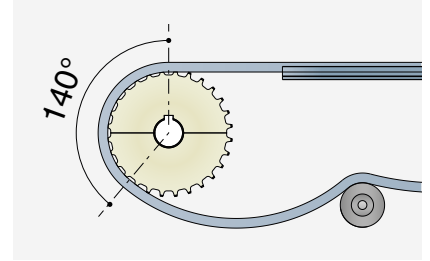

### Catenary

- Observe – length of catenary has to be longer than all other distances between return shafts. Recommended catenary length: 500-900mm, recommended return shaft distance: 500mm.
- Observe – catenary has to be long enough to release the chain/belt properly from the sprocket. Wrap the chain/belt tight enough around the sprocket to transmit the torque.
- Observe – smooth run of the chain/belt through the catenary. If chain/belt moves up and down, catenary is too short [1].
- Observe – fixed position of catenary. If it's jumping back and forth between the return shafts, the length of the dedicated catenary position is too short [2].

If catenary length cannot be adjusted correctly, install a tensioner or just put a gravity roller.

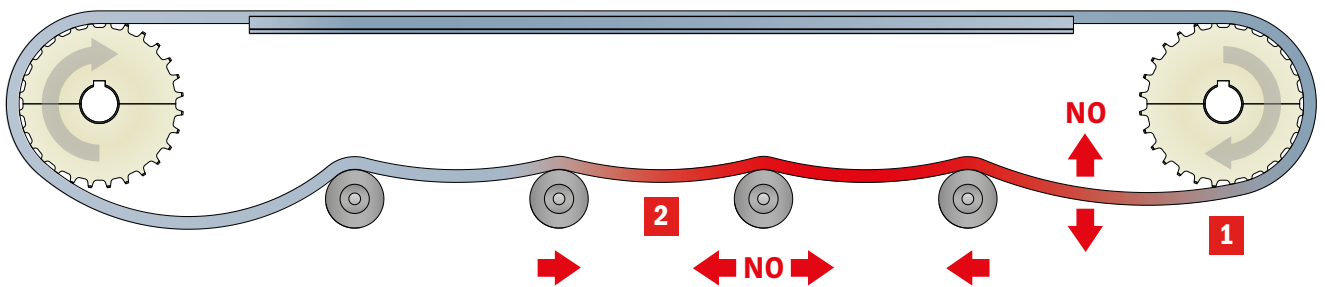

### Floating sprockets for wider belt conveyors

- Check, if sprockets are able to float on the shaft and self-adjust to expanding belt - if not, belt can walk on the sprockets.
- Check, if required, one sprocket has a fixed position - if not, gap between parallel belts can become undefined.

### Return system

- Observe – chain/belt must not drift aside in return part - if it does, adjust the conveyor level, check alignment of shafts.
- Check the dimension of return rollers, general rule: the bigger the better (with respect to backflex-radius).

### Drive/controls

- Observe – if chain/belt is jumping during start-up, reduce the acceleration.
- Observe – if chain/belt is being pushed too much by the product right after shut-down, reduce the deceleration. This helps to avoid chain/belt unwrapping from the sprocket.

For more info consult the Movex conveyor design recommendation section page 21.

## 8.10 Cleanliness

LEGEND: ● Stop conveyor & remove part that's being inspected | ● Check in production mode | ● Check in stand still

### Carry part of the conveyor

- Check idlers for free rotation and for embedded dirt and for sticky residues. Clean, if one or more of that criteria makes it necessary.
- Check wear strips for embedded dirt and for sticky residues. Clean, if one or more of that criteria makes it necessary.
- Check sprockets for embedded dirt and for sticky residues. Clean, if one or more of that criteria makes it necessary.
- Check magnetic curves for embedded dirt and for sticky residues. Clean, if one or more of that criteria makes it necessary.
- Check entire carry part for foreign pieces and remove.



### Return part of the conveyor

- Check return rollers (or other return elements) for free rotation and for embedded dirt and for sticky residues. Clean, if one or more of that criteria makes it necessary.
- Check curve return parts for foreign pieces and remove.
- Check entire return part for foreign pieces and remove.

### Chain/belt

- Check for embedded dirt and for sticky residues. Clean, if one or more of that criteria makes it necessary.

### Product guides

- Check guide rails for embedded dirt and for sticky residues. Clean, if one or more of that criteria makes it necessary.
- Check roller side guides for free rotation and for embedded dirt and for sticky residues. Clean, if one or more of that criteria makes it necessary.

### Start-up help

- Observe catenary movement and sprocket release during start-up. Apply water on belt and drive shaft, if the catenary does not behave as it should. That's particularly relevant after a longer shut-down period.

**ASSEMBLING  
MANUAL**

***Movex***

# ASSEMBLING MANUAL

9.1 Belts mounting option .....	142
9.2 Chain mounting block .....	144
9.3 Leveling feet - C500 Series .....	146

## Operation, safety & signalling

### Personal protection

In view of the experience gained over the years Movex S.p.A. advises you to wear personal protective equipment, during the maintenance, erection and placement of the conveyor:



Safety helmet to ensure head protection.



Safety shoes against the risk of slipping, impact, and falling objects.



Protective gloves against the risk of abrasions, cut and burns.



The use of safety glasses is always advisable.

If chemicals that pose a health risk are used in the machine/installation, the user must take the necessary safety precautions. The safety rules must be followed.

## **Warning!**

- During operation, adjustments and maintenance: always wear safety shoes.
- During operation, adjustment or maintenance: you must not be wearing any jewellery.
- Loose fitting clothing is very dangerous; secure or remove them.
- Keep long hair tied up and wear a safety helmet.
- Keep the work floor clean at all times.

**Pin Sphere®**  
AUTOLOCK

FIXING SYSTEM FOR:  
550/522 HD Series - One track belt, 510 Series and 530 Pro LBP

### Assembly/Disassembly

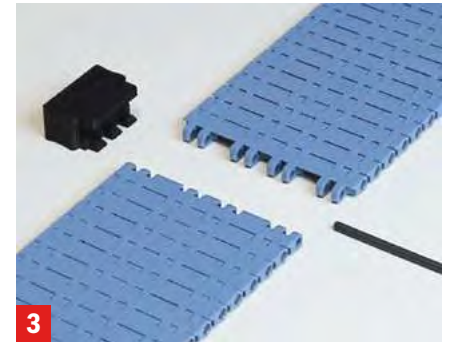
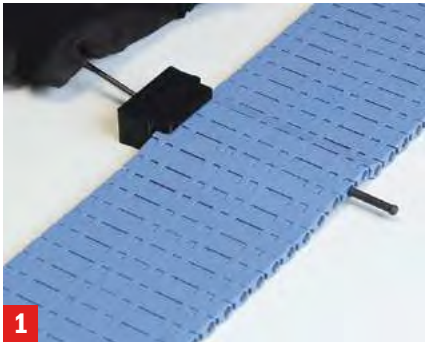

- Place the Movex tool between the modules and insert the pin punch inside the tool hole, with a little pressure the pin sphere can be unlocked [1].
- The pin sphere will come out of the belt [2].
- Now the belt is disassembled [3].

\*For 530 Pro LBP, the pin sphere can be removed with a flat screwdriver from the bottom of the belt.

**MOVEX TOOL**

The specific tool for belts developed to facilitate belt assembly and disassembly.  
For complete Movex Tool range please refer to our General catalog or contact our Sales force.



e.g. for 550 Series

### Ball clip

FIXING SYSTEM FOR:  
550 Pro M and 550 Pro FT.

### Assembly/Disassembly

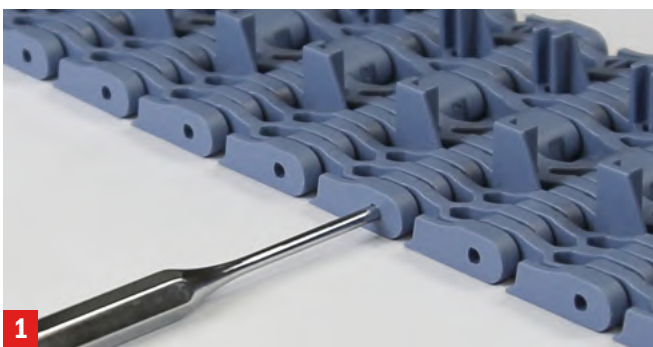

- To take away the locking of the rod remove the ball clip. This can be done by inserting a pin punch inside the rod's hole on the inside radius. [1].
- Remove the rod. Push again inside the rod's hole with pin punch. The rod will come out of the belt [2].
- Join the belt ends together by pushing a cross rod in from the right side of the belt [3]. Use only original straight rods, bent or deformed rods may affect the performance.
- To block the cross rod inside the belt, push the external plastic ball clip inside its seat.

## 9.1 Belts mounting options

### Grub screw

FIXING SYSTEM FOR:  
Zero contact Pro

#### Assembly/Disassembly

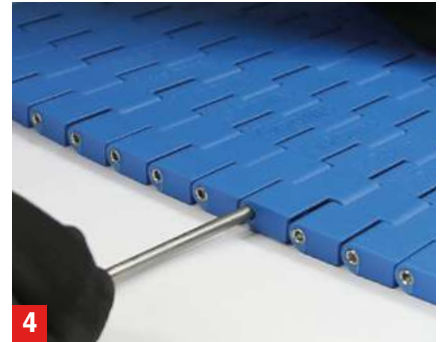
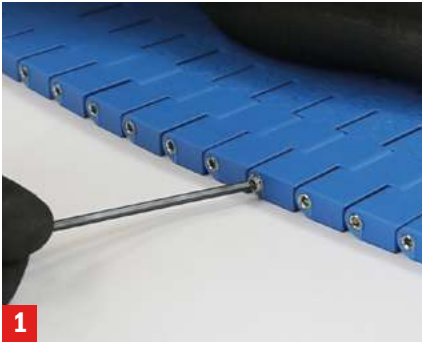

- To take away the locking of the rod remove the grub screw that is fitted on the outside radius. Use the correct size of hex key [1].
- Remove the metal rod. This can be done by inserting a pin punch inside the rod's hole, on the inside radius. The metal rod will come out of the belt [2].
- Join the belt ends together by pushing a cross rod in from the outside radius of the belt [3]. Use only original straight metal rods, bent or deformed rods may affect the performance.
- To block the cross rod inside the belt, with the help of hex key close the external grub screw [4].

### Plastic clip

FIXING SYSTEM FOR:  
All the other series

#### Assembly/Disassembly

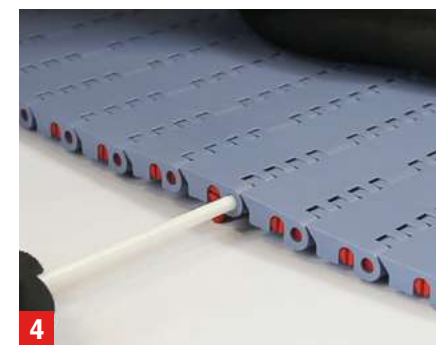
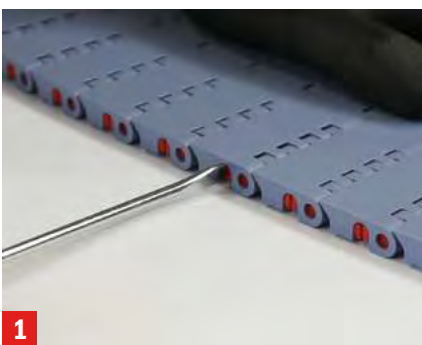

- To take away the locking of the rod remove the clip that is fitted on the outside radius. Use the correct size of blade screw driver [1].
- Remove the rod. This can be done by inserting a small blade screw driver inside the rod's hole passing through the slotted hole, on the inside radius. The rod will come out of the belt [2].
- Join the belt ends together by pushing a cross rod in from the outside radius of the belt [3]. Use only original straight rods, bent or deformed rods may affect the performance.
- To block the cross rod inside the belt, with the help of blade screw driver close the external clip. Use the correct size of blade screw driver [4].

\*For all the other series the clip can be found at one side of the belt.

## 9.2 Chain Mounting Block

The chain mounting block made in aluminium and stainless steel, is an essential tool that permits chain assembly and disassembling easier.

It's designed for different series and versions of steel and plastic chains with single hinge.

### Disassembling mode:

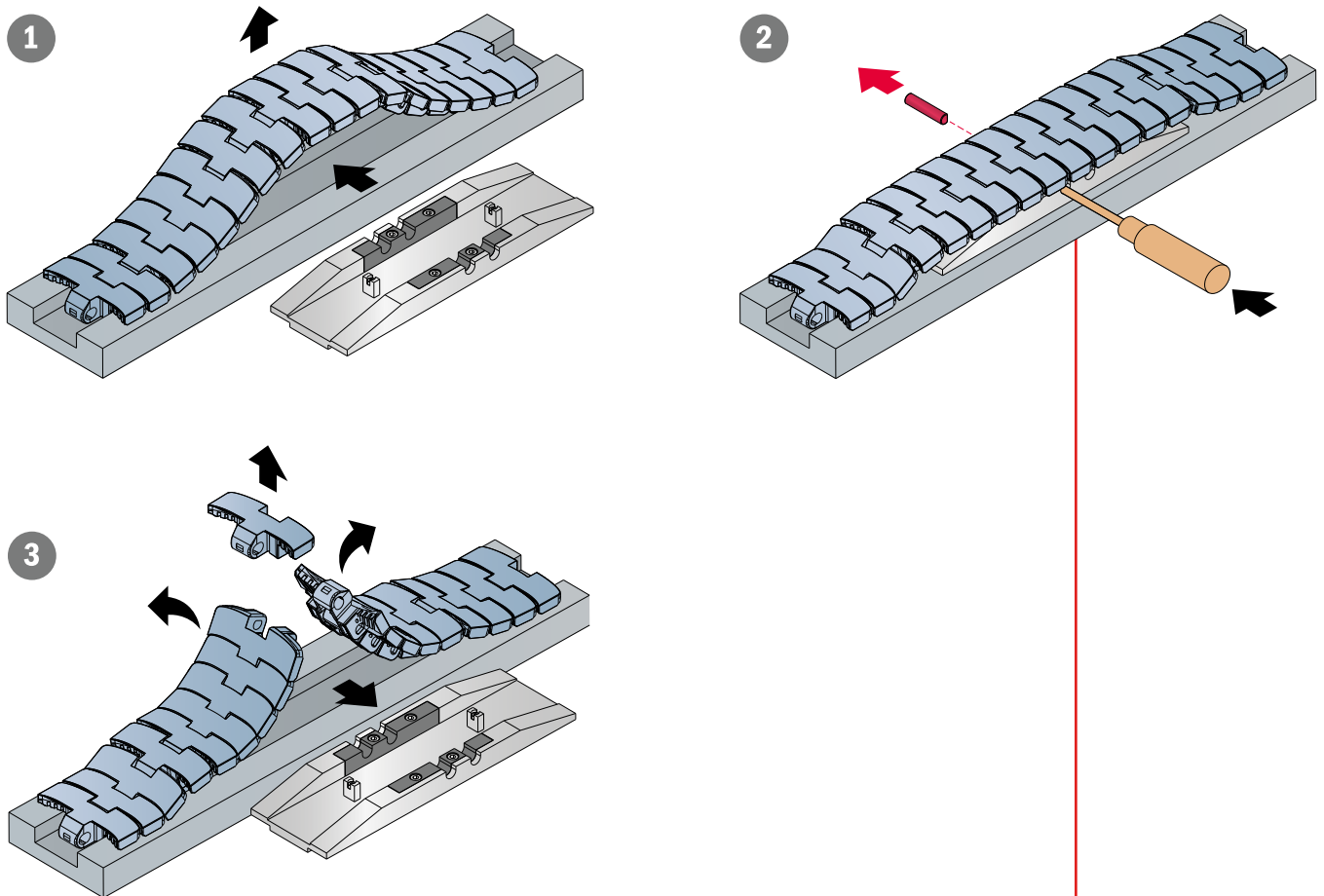

### Bore Position

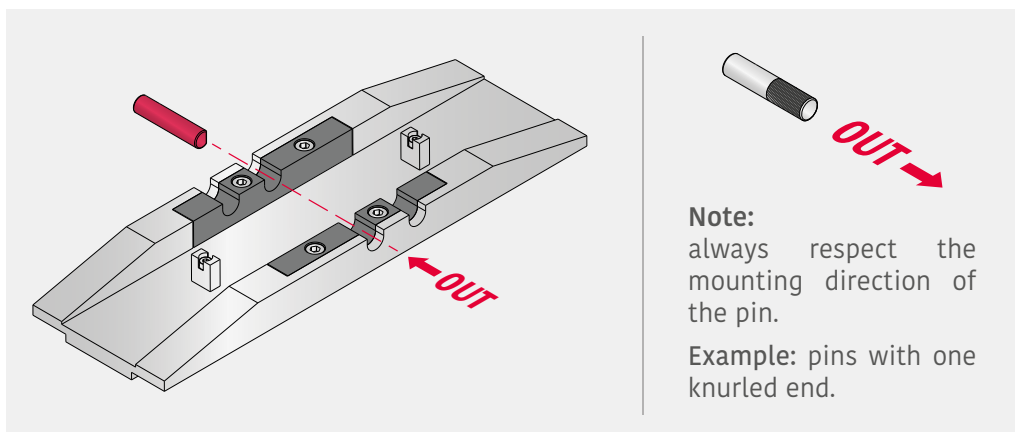



## 9.2 Chain Mounting Block

Assembling mode:

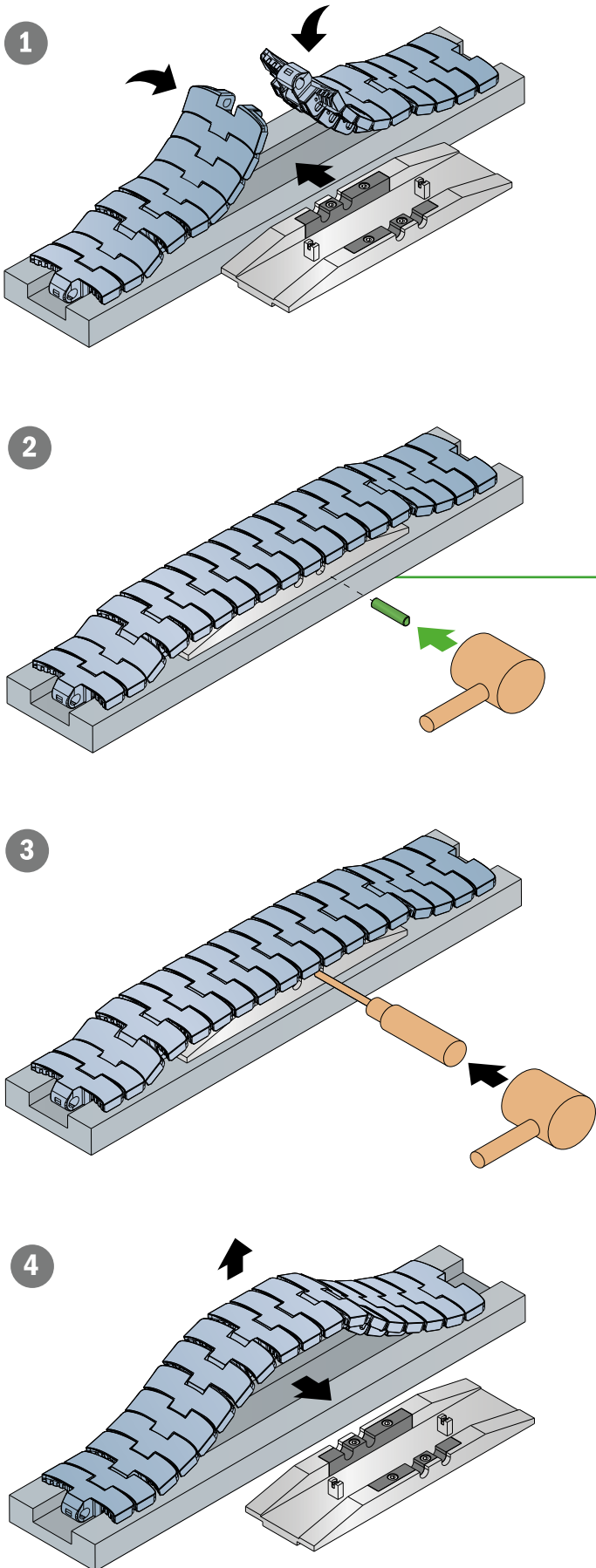

### Bore Position

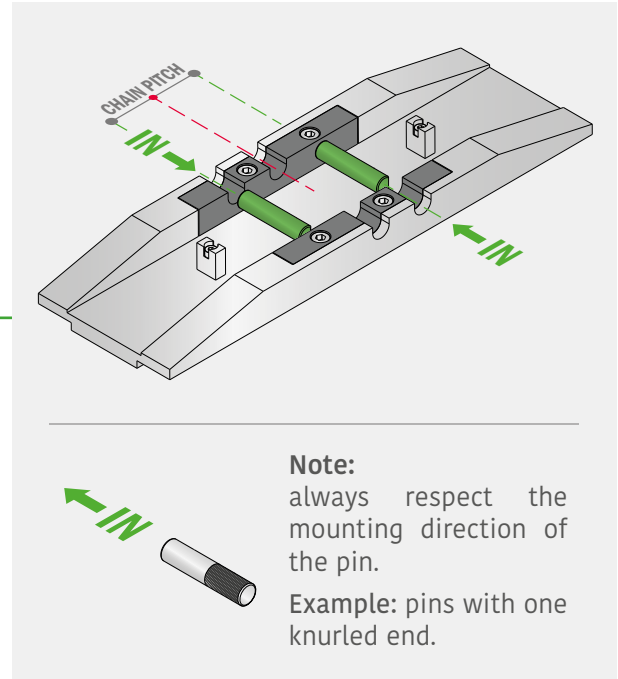

## 9.3 Leveling feet - C500 Series

### 1. Before installing the levelers be sure that:

Repeat the operations for all the levelers.

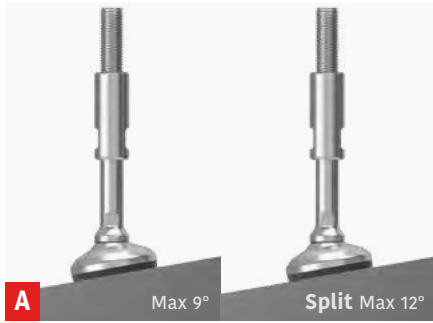

Floor inclination is not higher than product specifications (max 9° for standard version and max 12° for SPLIT version).



Support surface doesn't have any imperfection underneath and all around the leveler, if so, eliminate them or seal with industrial sealant compliant to your business requirements.



Do not place it close to floor grooves, if unavoidable, seal them with industrial sealant compliant to your business requirements.

### 2. To install the leveler:

Repeat the operations for all the levelers.



Lift the machine to get an easier access, so clean the bottom surface of the machine to be sure that the seal will close completely the thread part.



Check if the seal is mounted correctly and grease the thread part with food grade grease, removing excesses.



Screw and adjust height with a wrench on the proper groove, being sure not to exceed the max height.

### 3. Final step:



Lower the machine and eventually correct wrong heights, being sure the load is evenly distributed

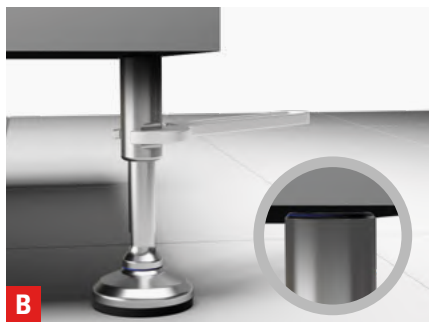

Tight the cover with a wrench on the proper groove, being sure the seal is against the machine.

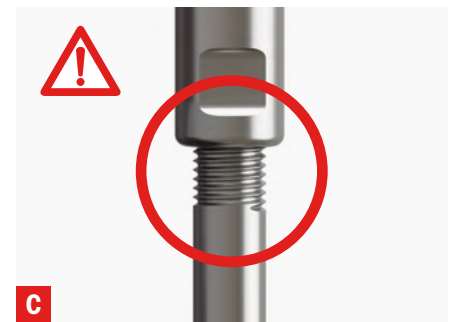

Check that thread part doesn't protrude, if so, please repeat the operation.



#### Warning:

To ensure hygienic requirements, all the various steps must be performed and respected.

## 9.3 Leveling feet - C500 Series

### 1. Before installing the levelers be sure that:



Support surface doesn't have any imperfection underneath and all around the leveler, if so, turn the base till a free part for hole is available.

### 2. To install the leveler:



Hold the drill at 2-3° of inclination, like the hole, and drill.



If necessary, place the guide against the base, so insert the drill through the holes and drill.



Use an anchoring rod or an expanding anchor; in both cases, be sure to follow instructions from supplier, so wait until anchors are ready to be used.

### 3. Final step:



Standard version: use washer and nut to fix the leveler to the floor.



Certified version: use always certified nut to guarantee product hygienic performances (different nut types can be ordered directly from our catalogue).

\* Max torque 10-12 Nm



#### Warning:

Follow same procedure for the levelers with double floor fixation.



# APPLICATION QUESTIONNAIRE

***Movex***

# APPLICATION QUESTIONNAIRE

<b>Entered data:</b> <input type="checkbox"/> Imperial sizes (inch) <input type="checkbox"/> Metric sizes (mm) Always write units together with figures you enter.	<b>Sprocket</b>		
	<b>Number of teeth</b>	<b>Bore diameter</b>	<b>Article Nr.</b>

Chain/Belt				
Name/series	Material	Width	Version (positioners)	Article Nr.

Conveyor				
Speed	Contamination (e.g. clean, dust, sticky, sand)	Lubrication (e.g. dry, water, oil, wet lube, dry lube)	Wear strips (e.g. UHMWPE, BluLub, Steel)	Return part (e.g. rollers, slidings)

Conveyor sections	1	2	3	4	5	6	7	8
Straight length								
Curve angle								
Curve radius								
Curve left or right								
Incline/decline angle								
Accumulation (mark if yes)	<input type="checkbox"/>	<input type="checkbox"/>	<input type="checkbox"/>	<input type="checkbox"/>	<input type="checkbox"/>	<input type="checkbox"/>	<input type="checkbox"/>	<input type="checkbox"/>
Occupation in %								
Temperature								

Replacement	Operating conditions/ Process description	Explain Clearly
Existing chain/belt		
Reason for replacement		
Chemical environment		
Cleaning agents (Send datasheet of chemicals)		
Anything else	<p><b>Remember:</b> Send photos, videos, data sheets, product descriptions, drawings... anything that helps to understand the application clearly.</p>	

Layout sketch

Send technical drawings (.stp/.dwg/.dxf).

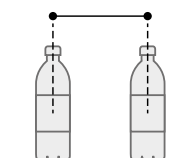

# Application Questionnaire

Product			
<b>Packaging</b> (e.g. bottle, crate, pack)	<b>Material</b> (e.g. glass, PET)	<b>Packed/filled product</b> (e.g. water, beer, powder detergent)	<b>Product center distance</b>
<b>Product dimensions</b> ( $\emptyset$ , L, W, H)	<b>Product weight... per piece</b>	<b>Product weight... per m of conveyor length</b>	<p>Product centre distance</p>  <p>Example</p>

## Product arrangement Always write units together with figures you enter. ( Mark option )

### Highest density

One wide chain/belt

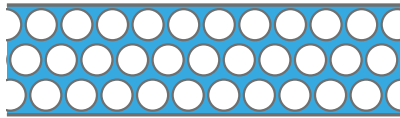

N tracks of parallel chains/belts

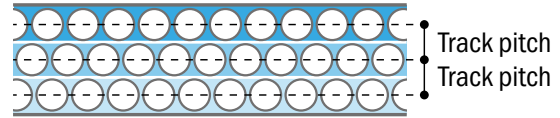

Track pitch (mm):

### M rows of product on N tracks of chains/belts

Option A

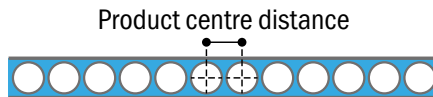

Example: 1 (M) on 1 (N)

Option B

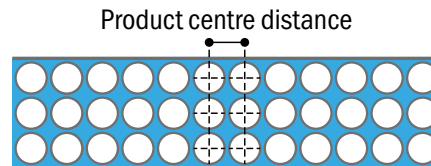

Example:  
3 (M) on 1 (N)

Product Rows (M):

Option C

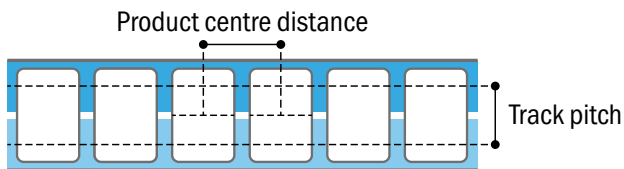

Example: 1 (M) on 2 (N)

Chain/belt tracks (N):

Track pitch (mm):

Sketch any different product arrangement

### Remember:

Send photos, videos, data sheets, product descriptions, drawings... anything that helps to understand the application clearly.

**Oadby Conveyors** *a division of Oadby Plastics Limited*

68 Scudamore Road  
Braunstone Frith Industrial Estate  
Leicester  
LE3 1UA

Telephone: 0116 232 4848  
Email: [convteam@oadbyplastics.co.uk](mailto:convteam@oadbyplastics.co.uk)

[www.oadbyconveyors.co.uk](http://www.oadbyconveyors.co.uk)

**Movex**<sup>®</sup>

working in partnership with

